

Item #: _____ **Qty #:** _____

Model #: _____

Project #: _____

SORTING SHELVES

KD TUBULAR



TRADITIONAL



TRADITIONAL DESIGN

FEATURES:

A solid die formed wall mounted rack shelf with solid end brackets.

CONSTRUCTION:

TIG-welded with exposed areas blended to a satin finish.

MATERIAL:

Brackets are 16 gauge type 300 series stainless steel.

Shelf is 16 gauge type 300 series stainless steel.

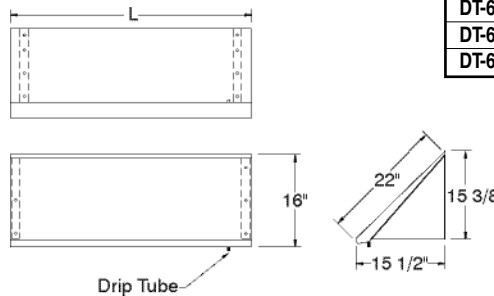

MODEL #	# of Racks	L	Wt
DT-6R-11	1	22"	20 lbs.
DT-6R-12	2	42"	30 lbs.
DT-6R-13	3	62"	40 lbs.
DT-6R-14	4	82"	50 lbs.

KD TUBULAR DESIGN

FEATURES:

A dual purpose open tubular design wall mounted rack shelf with solid end brackets bolted in field. Unit completely knock down.

CONSTRUCTION:

No welds. Unit is supplied with assembly hardware.

MATERIAL:

Brackets are 16 gauge type 300 series stainless steel.

Tubing is 1 5/8" diameter stainless steel 18 gauge tubing.

Stainless steel bolts (included).

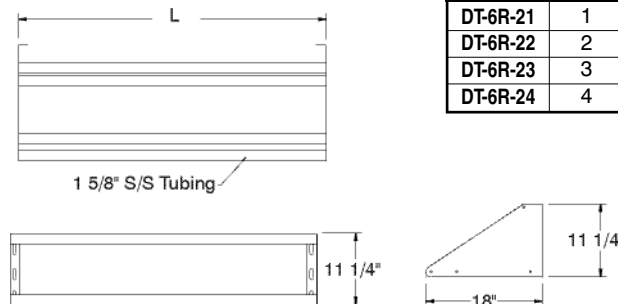

MODEL #	# of Racks	L	Wt
DT-6R-21	1	22"	15 lbs.
DT-6R-22	2	42"	23 lbs.
DT-6R-23	3	62"	30 lbs.
DT-6R-24	4	82"	38 lbs.



ADVANCE TABCO
SMART FABRICATION™
www.advancetabco.com

Customer Service Available To Assist You 1-800-645-3166 8:30 am - 8:00 pm E.S.T.

Email Orders To: customer@advancetabco.com. For Smart Fabrication™ Quotes, Email To: smartfab@advancetabco.com or Fax To: 631-586-2933

NEW YORK	GEORGIA	TEXAS	NEVADA
Fax: (631) 242-6900	Fax: (770) 775-5625	Fax: (972) 932-4795	Fax: (775) 972-1578

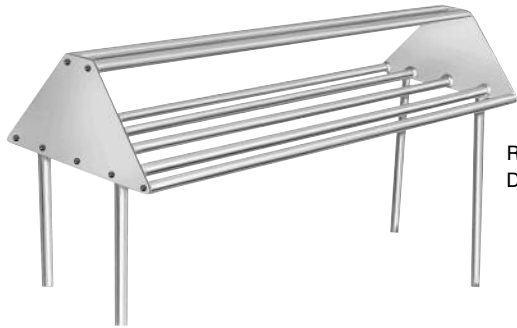

Recommended for D, G and U-Shaped Series Dishtables Only.

TABLE MOUNTED TUBULAR RACK SHELF DOUBLE SIDED DESIGN

Mounts to backsplash and end roll of dishtable

FEATURES:

A dual purpose double sided open tubular design table mounted rack shelf with solid ends.

CONSTRUCTION:

Factory assembled for ease of installation.

Mounts to dishtable with stainless steel bolts (included).

MATERIAL:

Side Plates are 14 gauge type 304 series stainless steel.

Tubing is 1 5/8" diameter 18 gauge type 300 stainless steel tubing.

9' AND LONGER HAVE CENTER SUPPORT

Shelf shipped separated from table to reduce freight costs and chance of shipping damage.

DOUBLE SIDED SLANT RACK SHELF

MODEL #	Qty.
DTA-79	

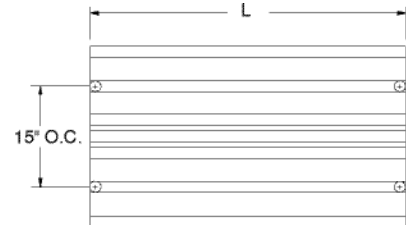

DTA-79

Minimum Length 48"

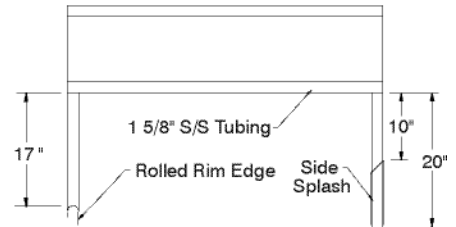
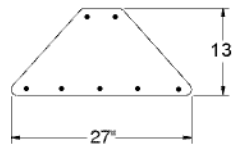

Stainless Steel Undershelves



FEATURES:

Stainless steel construction featuring the adjustable die cast leg clamp.

CONSTRUCTION:

No welds. Shelf completely die formed.

MATERIAL:

Stainless steel.

UNDERSHELVES

MODEL #	L	Wt.
DTA-SS-18	18"	15 lbs.
DTA-SS-24	24"	18 lbs.
DTA-SS-30	30"	24 lbs.
DTA-SS-42	42"	33 lbs.
DTA-SS-54	54"	42 lbs.
DTA-SS-66	66"	50 lbs.
DTA-SS-78	78"	60 lbs.

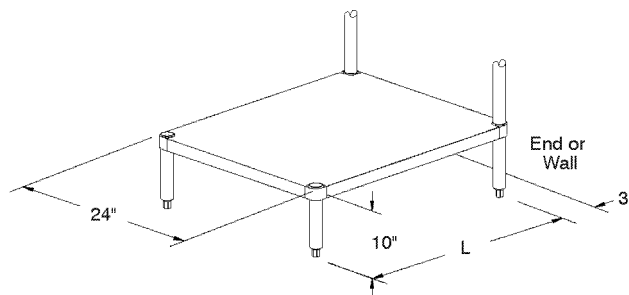

Shelving is Reversible (Left or Right)

Size Undershelf to be at least 6" shorter than dishtable.