



STAINLESS STEEL

18 GAUGE GALVANIZED WORK TABLES

TT, TTF & TTK Series

Item #: _____ Qty #: _____
 Model #: _____
 Project #: _____



FLAT TOP
TT Series



1 1/2" BACKSPLASH
TTF Series



5" BACKSPLASH
TTK Series



Fully Adjustable
Leg Collar

FEATURES:

TT Series top is furnished with 1 5/8" sanitary rolled rim on front and rear and square ends.

TTF Series top is furnished with 1 5/8" sanitary rolled rim on front and and 1 1/2" backsplash on rear.

TTK Series top is furnished with 1 5/8" sanitary rolled rim on front and and 5" backsplash on rear.

Two die formed hat channels are attached to underside of work table top to reinforce and maintain a level working surface.

Leg Collar at undershelf corner secures leg shelf to legs & is fully adjustable.

CONSTRUCTION:

All TIG welded. Exposed weld areas polished to match adjacent surface.

Top is sound deadened.

Die formed galvanized hat channels are secured to top by means of structural adhesive and weld studs.

Gussets welded to hat channels.

MATERIAL:

TOP: 18 Gauge Stainless Steel Type "430" Series

SHELF: 18 Gauge Galvanized Steel with Galvanized Steel Gussets

LEGS: 1 5/8" Diameter Tubular Galvanized Steel
1" Adjustable Plastic Bullet Feet

W	L	Flat Top			1-1/2" Splash			5" Splash		
		Model	Approx. Wt.	Approx. Cu. Ft.	Model	Approx. Wt.	Approx. Cu. Ft.	Model	Approx. Wt.	Approx. Cu. Ft.
24" WIDE	24"	TT-242-X	26 lbs.	2	TTF-242-X	26 lbs.	2	--	--	--
	30"	TT-240-X	31 lbs.	2	TTF-240-X	31 lbs.	2	--	--	--
	36"	TT-243-X	38 lbs.	2	TTF-243-X	38 lbs.	2	--	--	--
	48"	TT-244-X	53 lbs.	3	TTF-244-X	53 lbs.	3	--	--	--
	60"	TT-245-X	62 lbs.	3	TTF-245-X	62 lbs.	3	--	--	--
	72"	TT-246-X	71 lbs.	4	TTF-246-X	71 lbs.	4	--	--	--
	84"	TT-247-X	88 lbs.	4	TTF-247-X	88 lbs.	4	--	--	--
30" WIDE	96"	TT-248-X*	155 lbs.	5	TTF-248-X*	155 lbs.	5	--	--	--
	30"	TT-300-X	38 lbs.	2	TTF-300-X	38 lbs.	2	--	--	--
	36"	TT-303-X	43 lbs.	2	TTF-303-X	43 lbs.	2	--	--	--
	48"	TT-304-X	61 lbs.	3	TTF-304-X	61 lbs.	3	TTK-304-X	75 lbs.	6
	60"	TT-305-X	75 lbs.	4	TTF-305-X	75 lbs.	4	TTK-305-X	83 lbs.	7
	72"	TT-306-X	83 lbs.	4	TTF-306-X	83 lbs.	4	TTK-306-X	99 lbs.	8
	84"	TT-307-X	99 lbs.	5	TTF-307-X	99 lbs.	5	--	--	--
	96"	TT-308-X*	170 lbs.	6	TTF-308-X*	170 lbs.	6	--	--	--

*8' tables furnished with 6 legs



Customer Service Available To Assist You **1-800-645-3166** 8:30 am - 8:00 pm E.S.T.

For Orders & Customer Service:

Email: customer@advancetabco.com or Fax: 631-242-6900

For Smart Fabrication™ Quotes:

Email: smartfab@advancetabco.com or Fax: 631-586-2933

DIMENSIONS and SPECIFICATIONS

ALL DIMENSIONS ARE TYPICAL TOL ± .500"

All Units Shipped Unassembled (KD) for Reduced Shipping Costs.

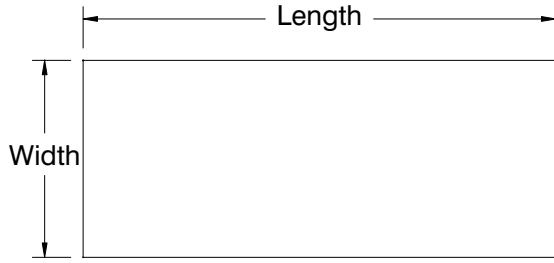

For Future Drawer Installation,
Order **TA-90 Drawer Adapter**
With The Drawer

TT SERIES

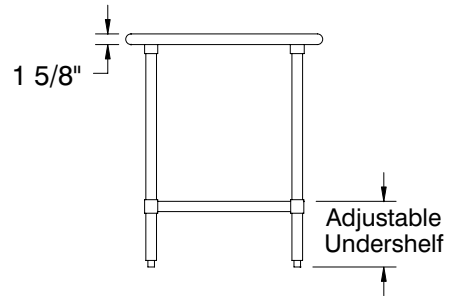
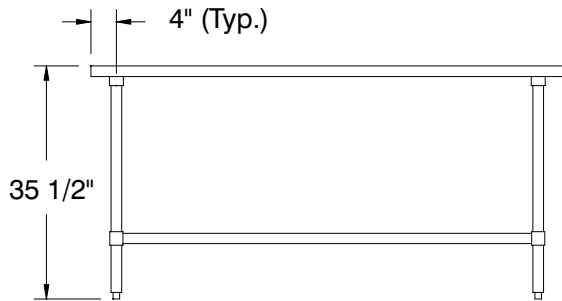

TTF SERIES

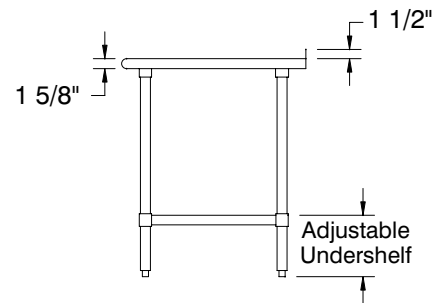
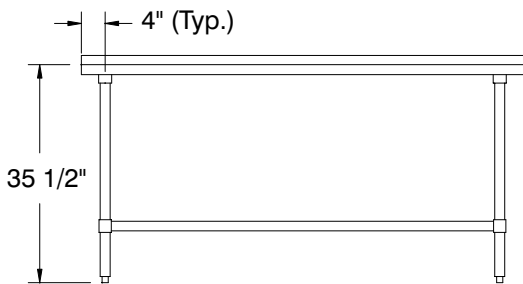

TTK SERIES

