

LCA-2 (w/LiquidBox QC/DII 3/16")

31.3" x 24.8" x 12.2"
(79.5cm x 63.0cm x 31.0cm)



Servers and airpots sold separately

- Accommodates 1/2gal (1.9L) and most 1gal (3.8L) bag-in-box (BIB) containers
- Attractive appearance and narrow 12" (30.5 cm) width
- FlavorGard® technology continuously monitors extract-to-water ratio and assures flavor consistency
- Refill or rinse LED lights alert the operator for concentrate or cleaning
- Ventilated Cabinet
- Insulated product cabinet assures maximum product life

Agency:



Specifications

Product #: 34400.0004

Product Ratio: 25:1-45:1

Connector: LiquiBox QC/D II

Water Access: Plumbed

Finish: Black

Dispense: Push Button

Legs: 4" Black Legs

Additional Features

Alt Disp Rate 2.5 oz/s(74ml/s)

Alt Product Ratio 25:1-65:1

Electrical & Capacity

Volts	Amps	Watts	Cord Attached	Plug Type	8oz cups/hr 236ml cups/hr	Input H ₂ O Temp.	Phase	# Wires plus Ground	Hertz
120	13.2	1575	Yes	NEMA 5-15P	810	60°F (15.5°C)	1	2	60
120/208	21	4331	-	N/A	1760	60°F (15.5°C)	1	-	-
120/240	24	5700	-	N/A	2344	60°F (15.5°C)	1	-	-

Plumbing Requirements

PSI	kPa	Fitting Supplied	Water Flow Required (GPM)
20-90	138-621	3/8" Male Flare Fitting	-

CAD Drawings

2D	Revit	KLC
●		



BUNN® reserves the right to change specifications and product design without notice. Such revisions do not entitle the buyer to corresponding changes, improvements, additions or replacements for previously purchased equipment. For most current specifications and other info visit bunn.com.

Created on:
06/15/2017

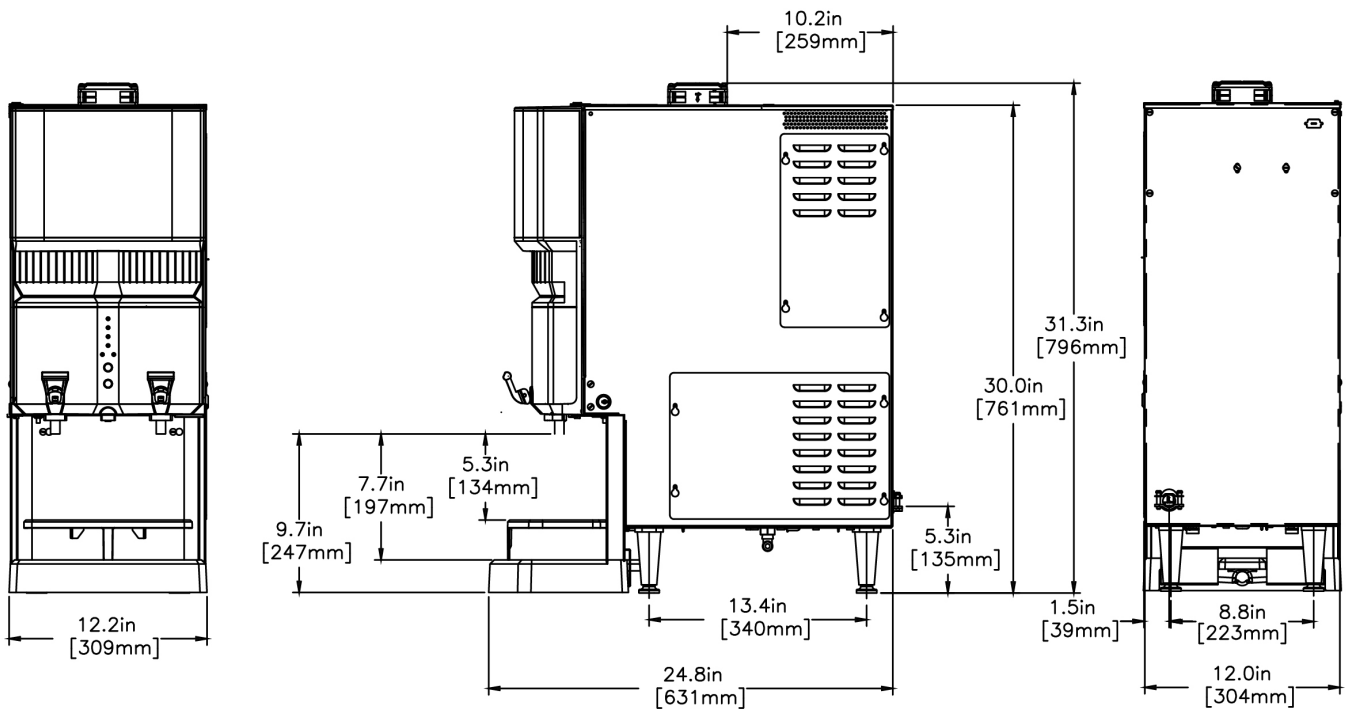
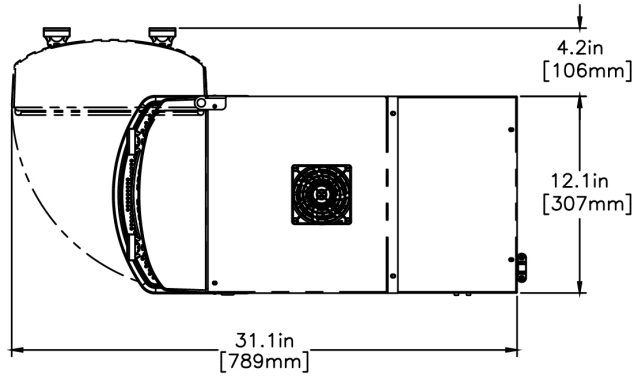

Unit				Shipping				
	Width	Height	Depth	Width	Height	Depth	Weight	Volume
English	12.2 in.	31.3 in.	24.8 in.	-	-	-	89.660 lbs	-
Metric	31.0 cm	79.5 cm	63.0 cm	-	-	-	40.670 kgs	-



BUNN® reserves the right to change specifications and product design without notice. Such revisions do not entitle the buyer to corresponding changes, improvements, additions or replacements for previously purchased equipment. For most current specifications and other info visit bunn.com.

Created on:
06/15/2017

Related Products & Accessories:LCA-2 (w/LiquidBox QC/DII 3/16")(34400.0004)

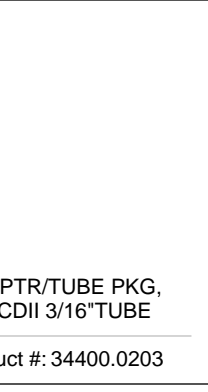

ADPTR/TUBE PKG,
QCDII 3/16" TUBE

Product #: 34400.0203



TUBE KIT, .188 PUMP
LCC/LCA

Product #: 34727.1000

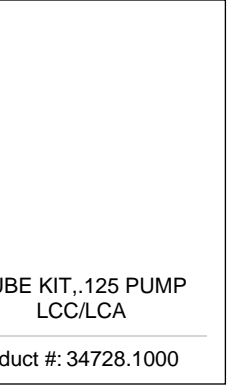

TUBE KIT, .125 PUMP
LCC/LCA

Product #: 34728.1000



KIT, DISPENSE RATIO
CAL LCA/LCC

Product #: 34843.1000



WATER FILTER,
EQHP-10L

Product #: 39000.0001



WATER FILTER,
EQHP-25L

Product #: 39000.0002



WATER FILTER,
EQHP-10

Product #: 39000.0004



WATER FILTER,
EQHP-25

Product #: 39000.0005



BUNN® reserves the right to change specifications and product design without notice. Such revisions do not entitle the buyer to corresponding changes, improvements, additions or replacements for previously purchased equipment. For most current specifications and other info visit bunn.com.

Created on:
06/15/2017