



MBSMP60-24A



## MBSMP-A SERIES

### Mega Top Sandwich/Salad Prep Units

#### MODELS

- MBSMP27-12A     MBSMP36-15A     MBSMP48-18A  
 MBSMP60-24A     MBSMP72-30A

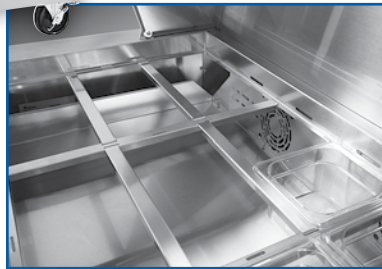

#### Drop-in section:

- Fans force cold air into this enclosed area keeping stored food items consistently cold
- A stainless steel divider prevents food spillage into the storage area beneath
- Accommodates 6" deep pans (4" standard)

### FEATURES

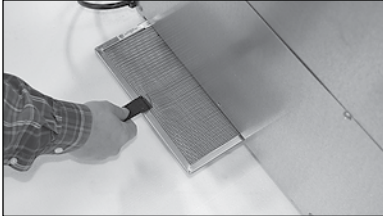

*Standard condenser filter screen, removable without tools, for easy condenser coil cleaning resulting in peak efficiency and extended equipment life.*

#### CONSTRUCTION

- Front-breathing design allows for zero-clearance installation on sides and back
- Stainless steel interior and exterior
- Foamed-in-place with low ODP polyurethane insulation
- Standard 9<sup>1</sup>/<sub>2</sub>" deep reversible cutting board
- Insulated top lid
- Wall thickness: 2"
- 6" overall height casters
- Adjustable heavy-duty vinyl-coated shelves
- Field reversible door on MBSMP27-12A

- 1/6 size pans included
- Pan adapter bars run front-to-back and side-to-side allowing mixed pan sizes to fit menu requirements
- Pan adapter bars lock together to hold pans in place

#### DOORS

- Self-closing
- Standard door swing configuration:
  - 1-door models ..... hinged right
  - 2-door models.....left hinged left, right hinged right
  - 3-door models.....left hinged left, middle hinged left, right hinged right
- Door width:
  - MBSP27-8A ..... 27<sup>1</sup>/<sub>2</sub>"
  - MBSP36-10A..... 17<sup>1</sup>/<sub>2</sub>"
  - MBSP48-12A ..... 23<sup>1</sup>/<sub>2</sub>"
  - MBSP60-16A ..... 29<sup>1</sup>/<sub>2</sub>"
  - MBSP72-18A..... 23<sup>1</sup>/<sub>2</sub>"

#### REFRIGERATION

- Self-contained refrigeration system
- Forced air system
- Coated evaporator coil
- Refrigerant: R-134a
- Temperature range: 32° to 40°F (0° to 4°C)

#### WARRANTY

- **Standard limited three year parts and labor**
- **Additional two year coverage on compressor part**

### OPTIONS

- 6" legs in lieu of casters (legs shipped loose)
- 4" casters in lieu of 6" casters (casters shipped loose)
- Stainless steel back
- Additional shelves
- Single or double overshell



- Refrigerated drawers (excluding MBSMP36-15A)



# TECHNICAL SPECIFICATIONS

MODEL	DIMENSIONS (in.)			DIMENSIONS (mm)			VOLTS	AMPS	UNIT H.P.	NO. OF DOORS	NO. OF SHELVES	NO. OF PANS	CAP. CU. FT.	SHIP CU. FT.	SHIP WT. LB/KG
	L	D*	H**	L	D*	H**									
MBSMP27-12A	27 <sup>1/2</sup>	36 <sup>7/8</sup>	44 <sup>5/8</sup>	699	937	1133	115	3.6	1/5	1	1	(12) 1/6	7.2	28.27	210/95
MBSMP36-15A	36	36 <sup>7/8</sup>	44 <sup>5/8</sup>	914	937	1133	115	3.6	1/5	2	2	(15) 1/6	9.9	35.61	266/121
MBSMP48-18A	48	36 <sup>7/8</sup>	44 <sup>5/8</sup>	1219	937	1133	115	5.2	3/8	2	2	(18) 1/6	13.4	45.97	323/147
MBSMP60-24A	60	36 <sup>7/8</sup>	44 <sup>5/8</sup>	1524	937	1133	115	5.2	3/8	2	2	(24) 1/6	16.2	56.33	378/172
MBSMP72-30A	72	36 <sup>7/8</sup>	44 <sup>5/8</sup>	1829	937	1133	115	5.2	3/8	3	3	(30) 1/6	20.4	66.69	413/188

\*Depth includes cutting board. \*\*Height includes casters.

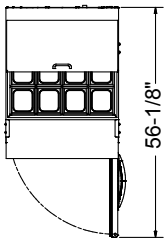

MBSMP27-12A  
PLAN VIEW

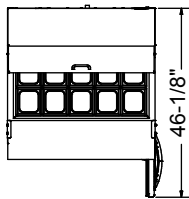

MBSMP36-15A  
PLAN VIEW

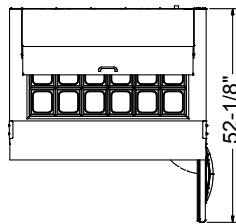

MBSMP48-18A  
PLAN VIEW

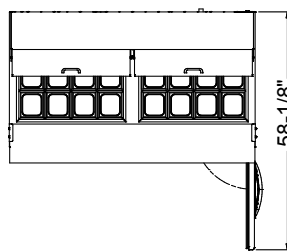

MBSMP60-24A  
PLAN VIEW

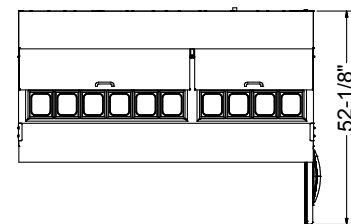

MBSMP72-30A  
PLAN VIEW

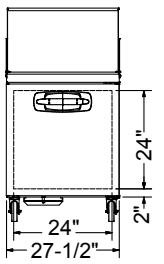

MBSMP27-12A  
ELEVATION VIEW

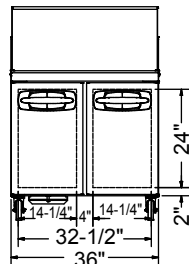

MBSMP36-15A  
ELEVATION VIEW

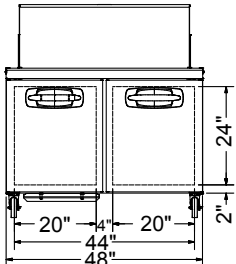

MBSMP48-18A  
ELEVATION VIEW

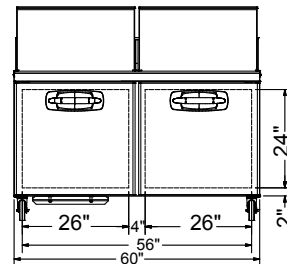

MBSMP60-24A  
ELEVATION VIEW

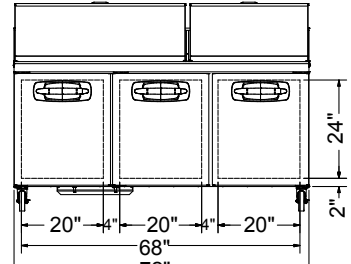

MBSMP72-30A  
ELEVATION VIEW

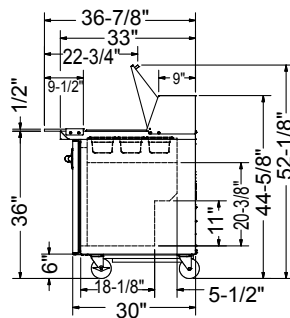

ALL MODELS  
SIDE VIEW

## LISTINGS



## HOOKUP

All models via plug in, 9 foot long flexible three wire 18/3 cord with molded plug.

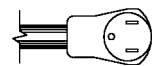

NEMA 5-15P

**OPTIONAL REFRIGERATED DRAWER CONFIGURATIONS (Not available on MBSMP36-15A model)**

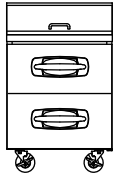

MBSMP27-12A-001

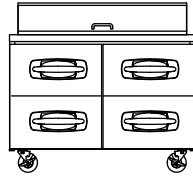

MBSMP48-18A-001

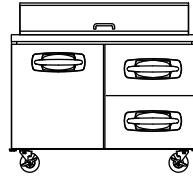

MBSMP48-18A-002

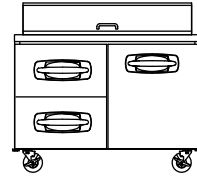

MBSMP48-18A-003

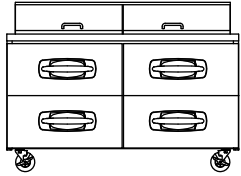

MBSMP60-24A-001

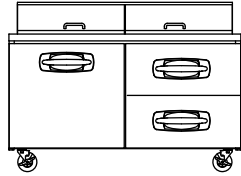

MBSMP60-24A-002

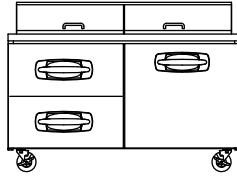

MBSMP60-24A-003

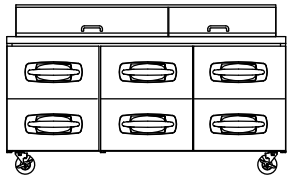

MBSMP72-30A-001

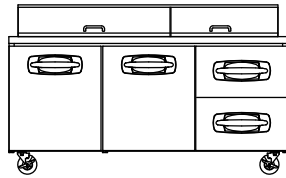

MBSMP72-30A-002

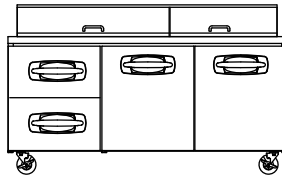

MBSMP72-30A-003

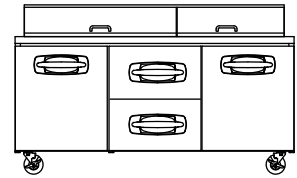

MBSMP72-30A-004

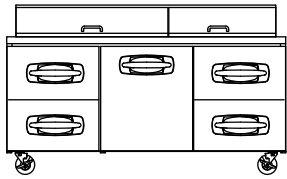

MBSMP72-30A-005

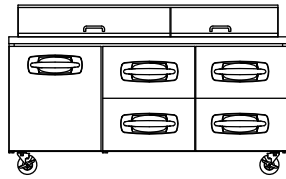

MBSMP72-30A-006

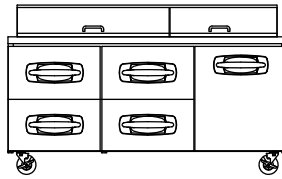

MBSMP72-30A-007

**PAN CONFIGURATIONS FOR REFRIGERATED DRAWERS (Not available on MBSMP36-15A model)**

MBSMP27-12A

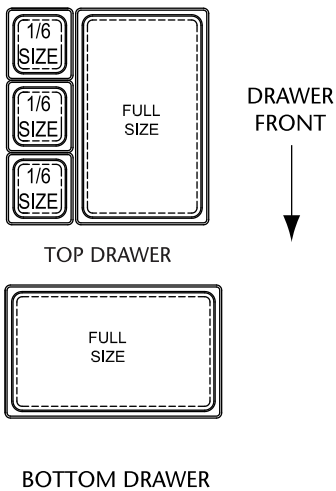

MBSMP48-18A & MBSMP72-30A

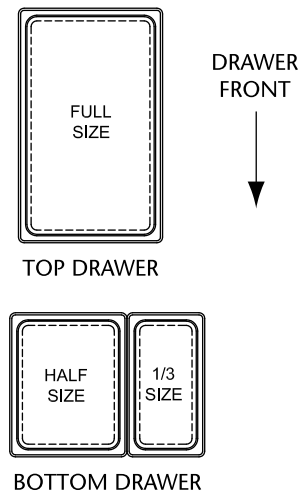

MBSMP60-24A

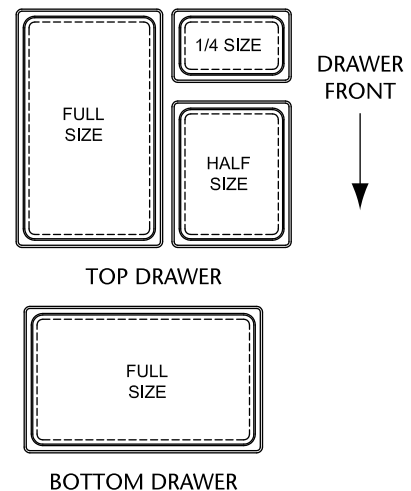

\*U.S. size pans, pans provided by others. Drawers accept up to 6-inch deep pans.

#### OPTIONAL OVERSHELF SPECIFICATIONS

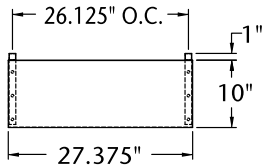

PLAN VIEW  
MBSP27-8A, MBSMP27-12A

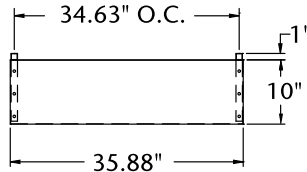

PLAN VIEW  
MBSP36-10A, MBSMP36-15A

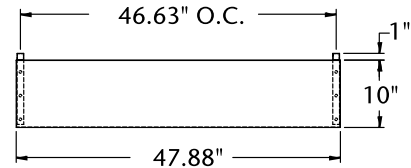

PLAN VIEW  
MBSP48-12A, MBSMP48-18A

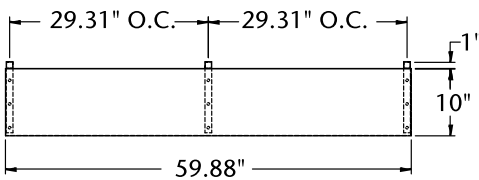

PLAN VIEW  
MBSP60-16A, MBSMP60-24A

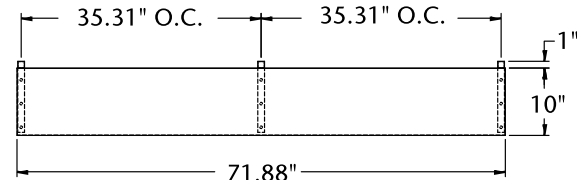

PLAN VIEW  
MBSP72-18A, MBSMP72-30A

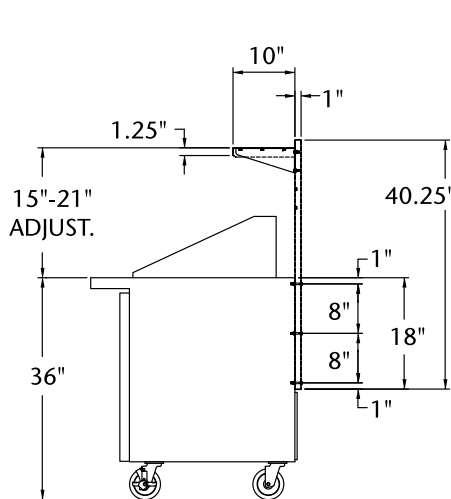

SINGLE SHELF SIDE VIEW

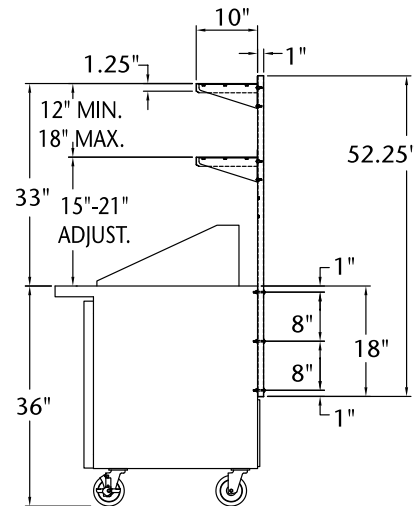

DOUBLE SHELF SIDE VIEW

#### BID SPECIFICATIONS

Item no. MBSMP\_\_\_\_A. Provide \_\_\_\_ Mega Top Sandwich/Salad Prep Unit(s), Master-Bilt® model no. MBSMP\_\_\_\_A.

Prep unit will feature will feature condenser coil filter screen, removable without tools, for simple preventative maintenance cleaning.

Prep unit will feature stainless steel

construction on interior and exterior and will be equipped with pan adapter bars allowing mixed sized pans.

The refrigeration system will be bottom mounted and self-contained. System will be front-breathing allowing for zero-clearance installation on sides and back.

Refrigerant will be R-134a. The temperature

range will be 32° to 40°F (0° to 4° C).

Prep unit to have standard limited three year parts and labor with additional two year coverage on compressor part.

Prep unit will be UL & C-UL listed and UL EPH classified.

**NOTE: Cabinet designed for optimum performance in air-conditioned area at 75°F ambient and 55% relative humidity. All specifications subject to change without notice.**