



T&S BRASS AND BRONZE WORKS, INC.
 2 Saddleback Cove / P.O. Box 1088
 Travelers Rest, SC 29690

Model No.
B-0155

Item No.

Travelers Rest, SC: 800-476-4103 • Simi Valley, CA: 800-423-0150 • Fax: 864-834-3518 • www.tsbrass.com



ADA Compliant



This Space for Architect/Engineer Approval

Job Name _____ Date _____

Model Specified _____ Quantity _____

Customer/Wholesaler _____

Contractor _____

Architect/Engineer _____

059X
 6" Swing Nozzle w/
 Stream Regulator Outlet

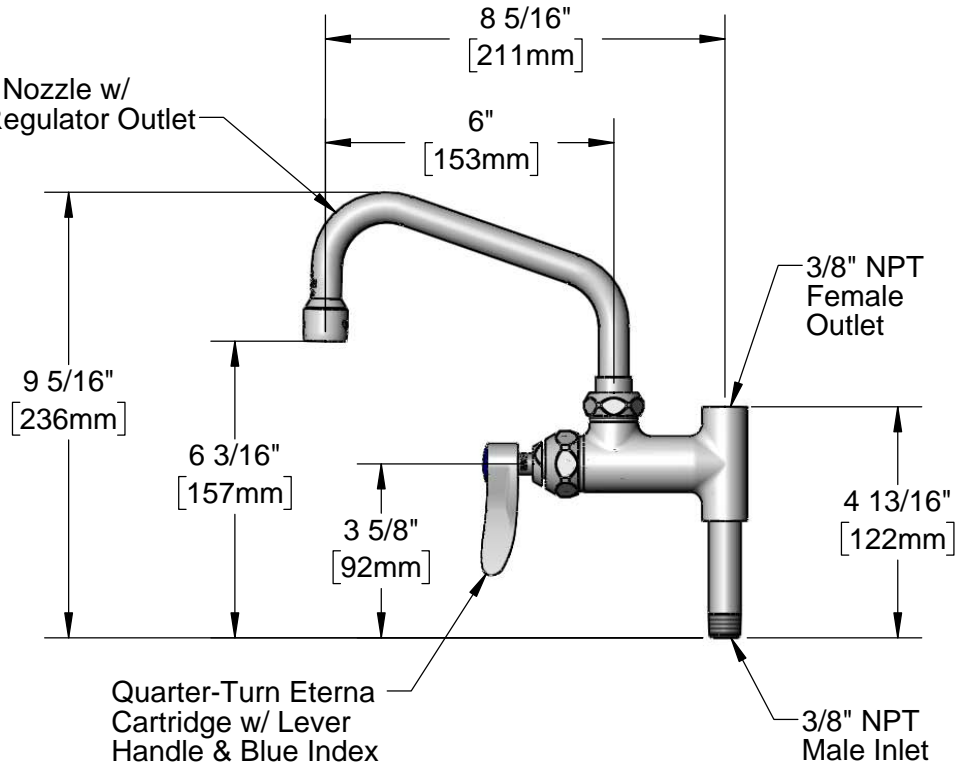
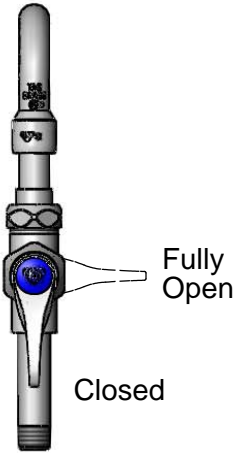

Notes:

1. The Add-On Faucet is an Addition to Pre-Rinse Units and is Installed in Outlets of Base Mixing Faucets of Units Before Fitting Riser Pipes
2. Lever Handle Controls Water On-Off Thru Nozzle Only. Pressure is Always "On" in the Riser Pipe (Controlled by Base Mixing Faucet)

Product Specifications:

Add-On Faucet w/ Quarter-Turn Eterna Cartridge w/ Spring Check, Lever Handle & 6" Swing Nozzle w/ Stream Regulator Outlet

Product Compliance:

ASME A112.18.1 / CSA B125.1
 NSF 61 - Section 9
 NSF 372 (Low Lead Content)
 ANSI A117.1 (ADA)



T&S BRASS AND BRONZE WORKS, INC.
 2 Saddleback Cove / P.O. Box 1088
 Travelers Rest, SC 29690

Model No.
B-0155
 Item No.

Travelers Rest, SC: 800-476-4103 • Simi Valley, CA: 800-423-0150 • Fax: 864-834-3518 • www.tsbrass.com

ITEM NO.	SALES NO.	DESCRIPTION
1	059X	6" Swing Nozzle w/ Stream Regulator Outlet
2	B-PT	Full Flow Stream Regulator, 55/64-27
3	009538-45	Swivel Washer
4	011429-45	Swivel Sleeves (2)
5	001074-45	O-Ring
6	000358-40	Nipple, 3/8" NPT x 3"
7	012443-40NS	Quarter-Turn Eterna Cartridge w/ Spring Check, RTC
8	001638-45NS	Lever Handle (New Style)
9	000925-45	Lab Handle Screw
10	018506-19NS	Blue Button Index, Press-in
11	019639-40	Quarter-Turn Eterna Cartridge RTC w/ Spring Check, Handle, Blue Index & Screw

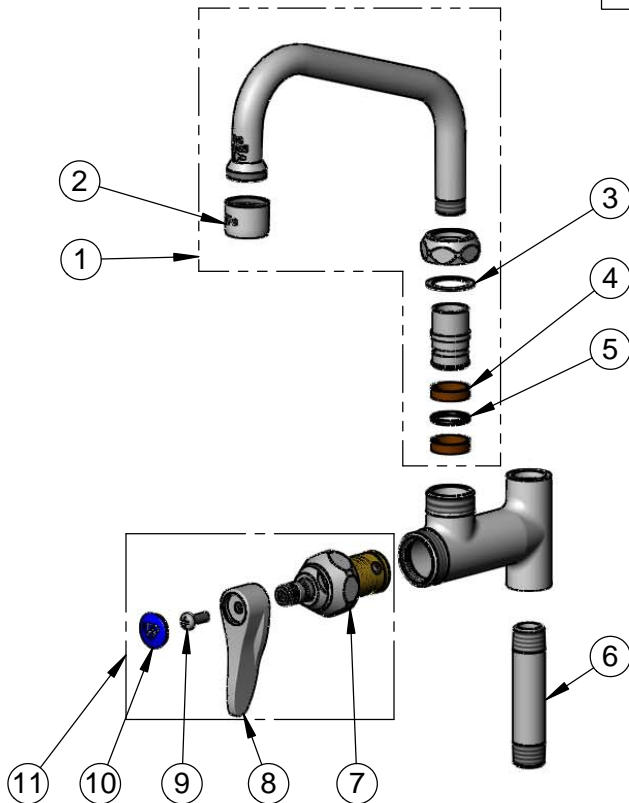

Product Specifications:
 Add-On Faucet w/ Quarter-Turn Eterna Cartridge w/ Spring Check, Lever Handle & 6" Swing Nozzle w/ Stream Regulator Outlet

Product Compliance:
 ASME A112.18.1 / CSA B125.1
 NSF 61 - Section 9
 NSF 372 (Low Lead Content)
 ANSI A117.1 (ADA)