



T&S BRASS AND BRONZE WORKS, INC.

2 Saddleback Cove / P.O. Box 1088
Travelers Rest, SC 29690

Model No.

B-0590

Item No.

Travelers Rest, SC: 800-476-4103 • Simi Valley, CA: 800-423-0150 • Fax: 864-834-3518 • www.tsbrass.com



ADA Compliant

This Space for Architect/Engineer Approval

Job Name _____ Date _____

Model Specified _____ Quantity _____

Customer/Wholesaler _____

Contractor _____

Architect/Engineer _____

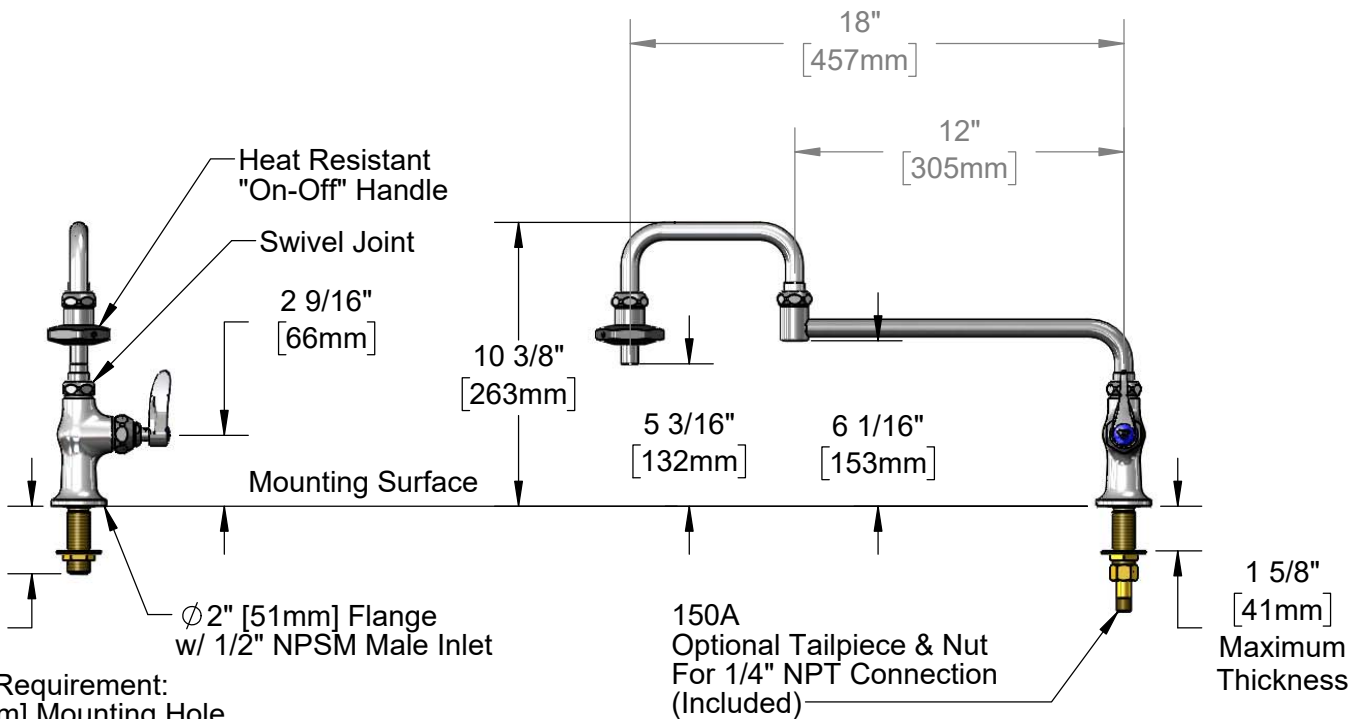
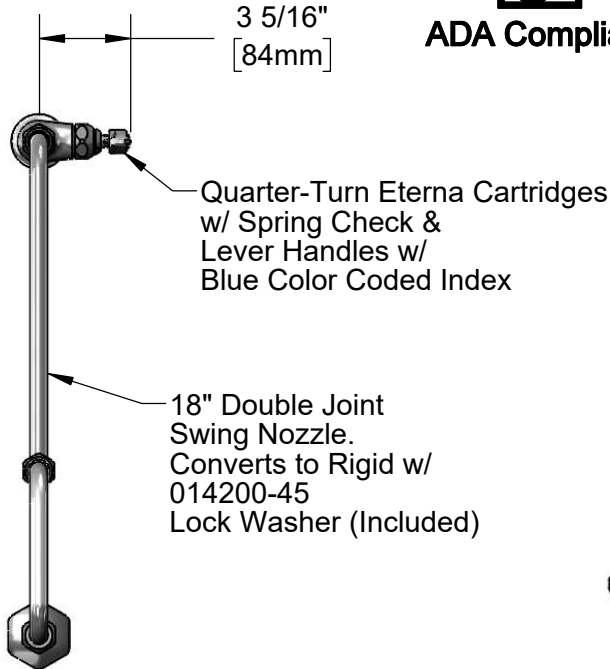

Rough-In Requirement:
Ø 1" [25mm] Mounting Hole

Product Specifications:

Single Hole Deck Mount Pot Filler Faucet, Quarter-Turn Eterna Cartridge w/ Spring Check, Lever Handle, 18" Double Joint Swing Nozzle, Heat Resistant Handle & 1/2" NPSM Male Inlet

Product Compliance:

ASME A112.18.1 / CSA B125.1
NSF 61 - Section 9
NSF 372 (Low Lead Content)



T&S BRASS AND BRONZE WORKS, INC.

2 Saddleback Cove / P.O. Box 1088
Travelers Rest, SC 29690

Model No.

B-0590

Item No.

Travelers Rest, SC: 800-476-4103 • Simi Valley, CA: 800-423-0150 • Fax: 864-834-3518 • www.tsbrass.com

ITEM NO.	SALES NO.	DESCRIPTION
1	000936-45	Handle Set Screw
2	001126-20	Handle w/ (2) Set Screws
3	035A	Outlet
4	000587-25	Spout Body
5	001498-25	Spout
6	001089-45	Seal
7	003426-45	O-Ring
8	002848-40	18" Double Joint Nozzle
9	002870-40	6" Front Section
10	002871-40	12" Back Section
11	009538-45	Swivel Washer
12	011429-45	Swivel Sleeves (2)
13	001074-45	O-Ring
14	014200-45	Star Washer, Anti-Rotation
15	019639-40	Quarter-Turn Eterna Cartridge RTC w/ Spring Check, Handle, Blue Index & Screw
16	012443-40NS	Quarter-Turn Eterna Cartridge w/ Spring Check, RTC
17	001638-45NS	Lever Handle (New Style)
18	000925-45	Lab Handle Screw
19	018506-19NS	Blue Button Index, Press-in
20	000999-45	Brass Lock Washer
21	002954-45	Shank Lock Nut
22	150A	1/4" NPT Tailpiece & Nut

Product Specifications:

Single Hole Deck Mount Pot Filler Faucet, Quarter-Turn Eterna Cartridge w/ Spring Check, Lever Handle, 18" Double Joint Swing Nozzle, Heat Resistant Handle & 1/2" NPSM Male Inlet

Product Compliance:

ASME A112.18.1 / CSA B125.1
NSF 61 - Section 9
NSF 372 (Low Lead Content)