



T&S BRASS AND BRONZE WORKS, INC.
 2 Saddleback Cove / P.O. Box 1088
 Travelers Rest, SC 29690

Model No.
MV-2516-24

Item No.

Travelers Rest, SC: 800-476-4103 • Simi Valley, CA: 800-423-0150 • Fax: 864-834-3518 • www.tsbrass.com

This Space for Architect/Engineer Approval

Job Name _____ Date _____

Model Specified _____ Quantity _____

Customer/Wholesaler _____

Contractor _____

Architect/Engineer _____

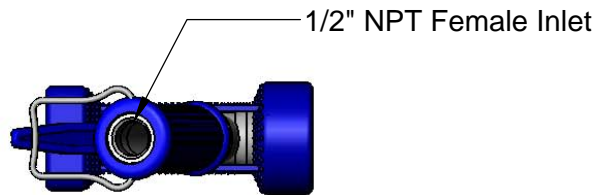
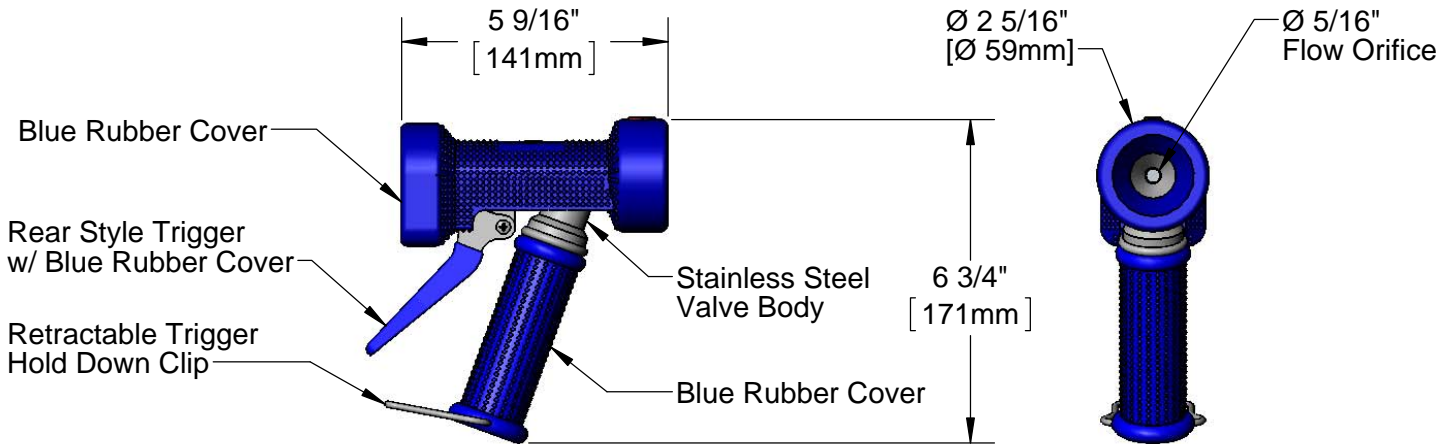
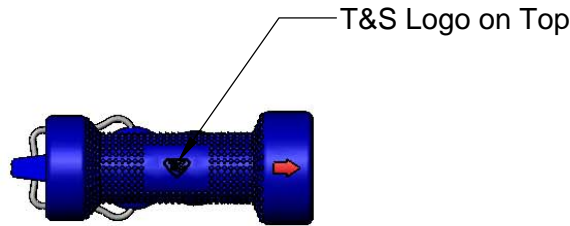
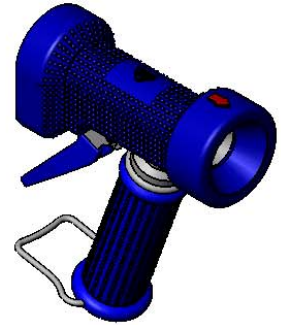

Product Specifications:
 Stainless Steel Water Gun w/ Blue Rubber Cover, Rear Style Trigger & Ø 5/16" Flow Orifice

Product Compliance:
 NSF 61 Exempt (Non-Potable)