

REFRIGERATOR MANUFACTURER
Turbo air
 more durable, efficient, beautiful

4184 E. Conant St.
 Long Beach, CA 90808
 Tel. 310-900-1000
 Fax. 310-900-1077
www.turboairinc.com

Project :	
Model # :	
Item # :	Qty :
Available W/H :	
Approval :	

Chef Bases (Extended Top)

*Chef Bases
 Super Deluxe Series*

Patented Self-Cleaning Condenser



This product is equipped with a fine mesh filter to the front of the condenser to catch dust, and a rotating brush that moves up and down daily to remove excess buildup outward and away.

**Model : TCBE-82SDR-N
 TCBE-82SDR-E-N**



TCBE-82SDR-N

- Each drawer accommodates up to 4" deep sixth (1/6) size pans (drawer pans not included)



TCBE-82SDR-E-N†

≡ FEATURES & BENEFITS ≡

■ Self-Cleaning Condenser

The accumulation of dust in the condenser can cause the failure or breakdown of refrigerators. Refrigerators run normally until they reach a certain level of accumulation. At some point, when they are over the limit, their performance drops quickly resulting in damage to, or disposal of the stored products inside. The Self-Cleaning Condenser device keeps the condenser clean and prevents system failure by automatically brushing daily.

■ Hydrocarbon refrigerants (R-290)

With innovative and eco-friendly technology, Turbo Air brings you hydrocarbon refrigerators designed to meet the new standards of the EPA and DOE in 2017. Hydrocarbon refrigerants do not deplete the ozone layer and have very low contribution to global warming (ODP-0, GWP-3).

■ Strong body and durable construction

Built with heavy duty 16 ga. stainless steel, Chef Base top is manufactured of one-piece reinforced stainless steel to ensure durability.

■ Digital temperature display on front panel

■ Top is insulated to eliminate heat transfer to the interior of cabinet

■ Flat Top Countertops

TCBE-36SDR-(E)-N6/48/52SDR-N supports up to 788 pounds of equipment. TCBE-72/82SDR-(E)-N supports up to 1,192 pounds of equipment. TCBE-96SDR-(E)-N supports up to 1,435 pounds of equipment.

■ Durable stainless steel drawers

■ Side mount compressor unit

With compressors positioned on the side of the unit, our refrigerators can now be serviced without being moved. Our innovative, front breathing feature also allows this model to be highly efficient in narrow spaces.

■ High-density polyurethane insulation

The entire cabinet structure and solid doors are foamed-in-place using high density, CFC free polyurethane insulation.

■ Refrigerator holds 33°F ~ 38°F for the best in food preservation



Model	Drawers	CU./FT.	Countertop Weight Capacity (lbs.)	HP	AMPS	Crated Weight (lbs.)	L x D x H [*] (inches)
TCBE-82SDR-N	4	16.04	1192	1/3	4.1	469	835/8 x 32 x 20 1/2
TCBE-82SDR-E-N†	4	16.04	1192	1/3	4.1	498	895/8 x 32 x 20 1/2

ELECTRICAL DATA	TCBE-82SDR-N	TCBE-82SDR-E-N†
Voltage	115/60/1	115/60/1
Plug Type	Ⓜ NEMA 5-15P	Ⓜ NEMA 5-15P
Full Load Amperes	4.1	4.1
Compressor HP	1/3	1/3
Cord Length (ft.)	9	9
Refrigerant	R-290	R-290
DIMENSIONAL DATA		
Ext. Length Overall (in.)	83 ⁵ / ₈ (2124mm)	89 ⁵ / ₈ (2276mm)
Ext. Depth Overall (in.)	32 (813mm)	32 (813mm)
Ext. Height Overall (in.)*	20 ¹ / ₂ (521mm)	20 ¹ / ₂ (521mm)
# of Drawers	4	4
# of Pans	60	60
Net Capacity (cu. ft.)	16.04	16.04
Net Weight (lbs.)	412	432
Gross Weight (lbs.)	469	498

Design and specifications subject to change without notice.
Actual shipping weight may differ due to extra packing materials for product protection.
* Height does not include 6" for caster height.
† Optional extended top available at **additional \$250 (net) Price to dealer net.**

■ **WARRANTY : 3 Year Parts and Labor Warranty
Additional 2 Year Warranty on Compressor**

- **Anti-corrosion coated evaporator**
- **Self-contained system**
- **5" dia. swivel casters standard**
- **Legs available (optional)**

■ **OPTIONAL ACCESSORIES :**

- 6" stainless steel leg: 30221M0600

PLAN VIEW

(unit : inch)

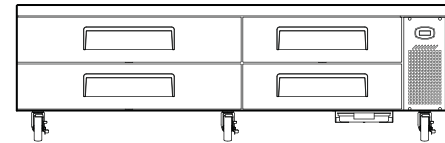

FRONT VIEW

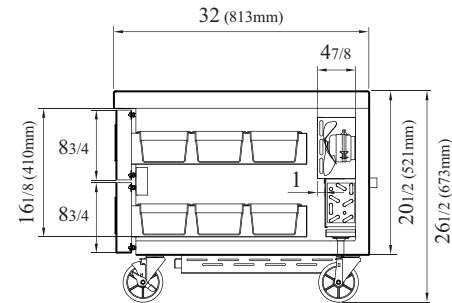

SIDE VIEW

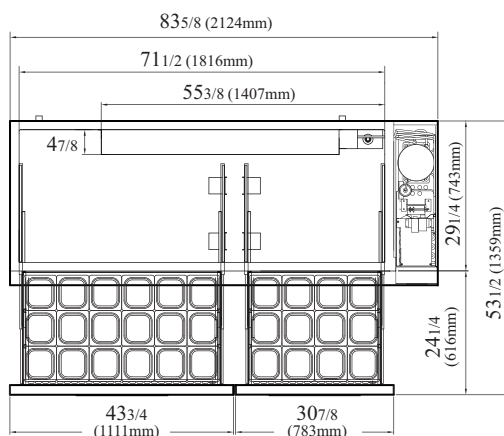

PLAN VIEW

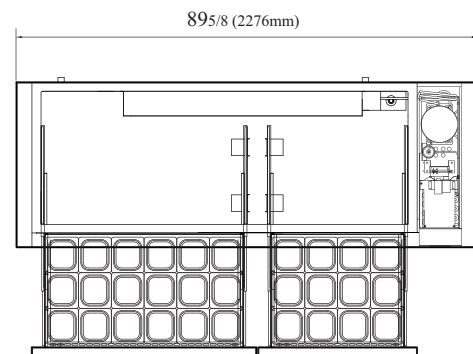

EXTENDED TOP PLAN VIEW

Ver.20180206



- Turbo Air : 800-627-0032
- GK : 800-500-3519
- Warranty : 800-381-7770
- AC : 888-900-1002

