



BEVERAGE-AIR

3779 Champion Blvd., Winston-Salem, NC 27105
1-888-845-9800 Fax# 1-336-245-6453
<http://www.Beverage-Air.com>

Item No. _____
Quantity _____

**DRAFT BEER EQUIPMENT
DIRECT DRAW DISPENSERS
DD SERIES**

**MODELS:
DD36-1-B
DD36-1-S**

**CUSTOMER'S CHOICE FOR A HOT LOCATION
Tested & Certified to Ambient Class of 100°F**

**3 Year Parts/Labor Warranty
Additional 2 Year Compressor Warranty**

CABINET CONSTRUCTION

Standard, cabinet exterior construction includes attractive, wear resistant vinyl on steel in black exterior finish. Top is made from heavy-duty stainless steel including drip tray for easy cleaning. Stainless finish options available.

Standard interior construction utilizes galvanized steel walls and ceiling. Reinforced floor and door sills are made from heavy-duty stainless steel to provide long lasting service.

Door is self-closing and includes key lock. Magnetic gasket provides positive door sealing.

Foamed-in-place CFC and HCFC-free polyurethane insulation enhances the structural strength of the cabinet and helps increase energy efficiency.

Three-inch (3") insulated tower is provided. Tower is adapted to have a continuous source of cold air channeled into it to keep beer at its coldest, best quality the moment it is dispensed.

REFRIGERATION

Models feature forced air refrigeration to keep beer in kegs ice cold for dispensing. Refrigeration system uses R134a refrigerant, which is CFC and HCFC-free for compliance with environmental safety concerns.

ELECTRICAL

Units wired at factory and ready for connection to a 115/60/1 phase, 15 amp dedicated outlet. 8' long cord and plug set included.

SPECIAL FEATURES

- Stainless finish options available

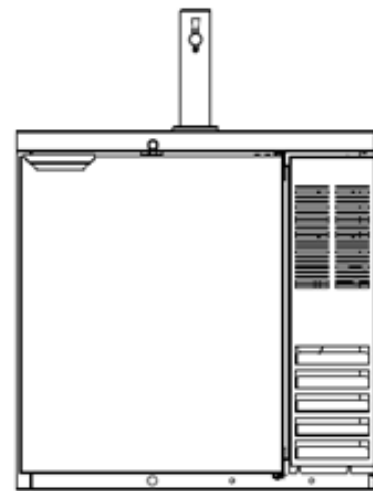

**DD36-1-B
IMAGE COMING SOON**

ELECTRICAL CONNECTION

Units pre-wired at factory and include 8' long cord and plug set.



115/60/1
NEMA-5-15P

Available From:



*Note: Not all markings may apply to all model variations.

Model Specified _____	Store# _____
Location _____	Quantity _____



Direct Draw Dispenser
Models: DD36

MODEL	DD36
EXTERNAL DIMENSIONAL	
Length Overall (inches)	36"
Length Overall (mm)	914
Depth Overall (inches)	23 1/2"
Depth Overall (mm)	597
Height Overall— (inches)	36"
Height Overall—(mm)	914
Depth with door open (inches)	48 3/4"
Number of doors	1
INTERNAL DIMENSIONAL	
NET Capacity (cubic ft.)	8.8
NET Capacity (Liters)	249
Internal Length Overall (inches)	24 1/4"
Internal Length Overall (mm)	616
Internal Depth Overall (inches)	20"
Internal Depth Overall (mm)	508
Internal Height Overall (inches)	29 1/2"
Internal Height Overall (mm)	749
Number of Kegs (1/2 barrel size)	1
ELECTRICAL DATA	
Full Load Amperes 115/60/1	5.0
REFRIGERATION DATA	
Horsepower	1/5
WEIGHT DATA	
Gross Weight (Crated lbs)	250
Gross Weight (Crated kg)	113

PLAN VIEWS

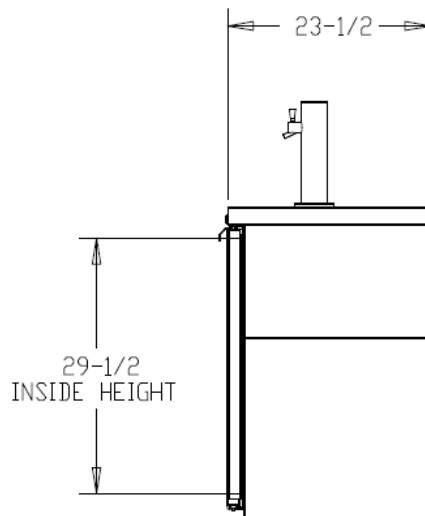
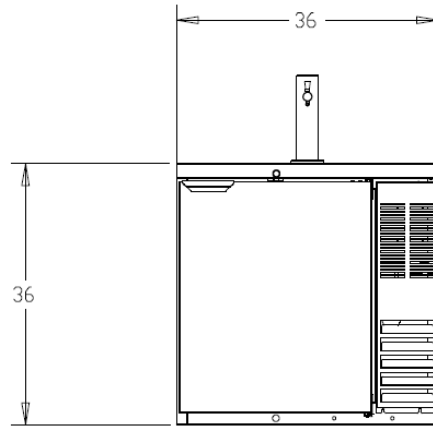
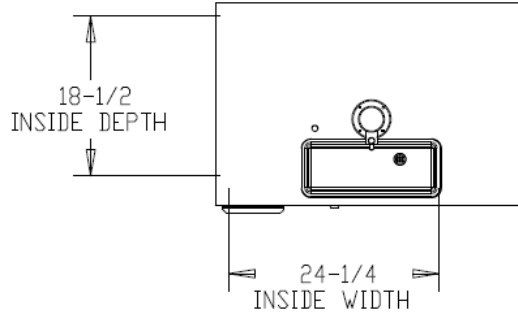

*Note: Not all markings may apply to all model variations.

BEVERAGE-AIR® CORPORATION

3779 Champion Blvd. • Winston-Salem, NC 27105 USA • (336) 245-6400 • Fax (336) 245-6453 • (888) 845-9800 • www.beverage-air.com

Specifications are subject to change without prior notice. 07/14