

300-HW Series

Hot Food Holding Drop-In Well



300-HWI/D6



300-HW/D443

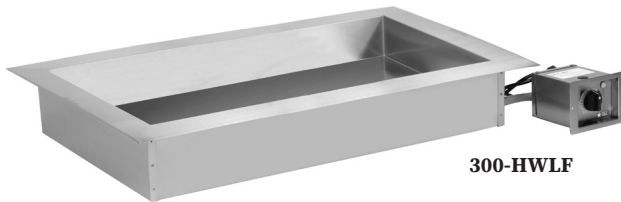

300-HWLF



• The gentle heating capability of Halo Heat significantly extends hot food holding life without continuing the cooking process.

- Provides a more appealing product with better appearance and fresher taste.
- Front-of-the-house use with an existing counter, overhead heating, and sneeze guard system or drop into a prep table for hot food plating convenience.
- Easy drop-in installation without the need of water or drainage connections and the related installation and water usage costs.
- Maintenance savings with the elimination of lime and scale buildup associated with steam table holding.
- Increase employee safety with the elimination of burning steam when changing pans.
- Adjustable thermostat with remote control suitable for mounting provides holding temperature flexibility without high steam table temperatures to scorch or burn.
- Stainless steel interior walls are easy to clean with coved corners on two sides of the well.
- HWI series with individual wells and independent controls expands your menu options.



ANSI/NSF 4



IP X3

Short Form Spec

The Alto-Shaam 300-HW is a hot food holding well with a stainless steel exterior. The hot well includes stainless steel interior walls with coved corners on two sides. HW and HWLF models are controlled by a single adjustable thermostat with a range of 1 through 10 and includes an indicator light. HWI and HWILF models are controlled by three (3) adjustable thermostats with a range of 1 through 10, each with an indicator light. The thermostat control is attached to the hot well base by a 72" (1892mm) flexible and water tight conduit.

The hot well base is available in two depths. The 4-3/8" (111mm) deep hot well holds 4" (100mm) deep pans and the 6-3/8" (162mm) deep hot well holds 150mm deep pans. Both hot wells will hold a combination of standard (gastronorm) pan sizes. The HW and HWLF D4 and D6 hot wells include six (6) half/third-size pan divider bars and two (2) full-size pan divider bars. The HW/D443 and HW/D643 hot wells include nine (9) half/third-size divider bars and two (2) large divider bars. The HWI and HWILF hot wells include six (6) half/third-size divider bars. The HWI/D443 and HWI/D643 hot wells include nine (9) half/third-size divider bars.

- 300-HW/D4:** 111mm depth, accepts three (3) Full-size (gastronorm) pans
- 300-HW/D6:** 162 mm depth, accepts three (3) Full-size (gastronorm) pans
- 300-HWLF/D4:** 111mm depth, accepts three (3) Full-size (gastronorm) pans
- 300-HWLF/D6:** 162 mm depth, accepts three (3) Full-size (gastronorm) pans
- 300-HW/D443:** 111mm depth, accepts three (3) Full-size (gastronorm) pans and three (3) third-size (gastronorm) pans
- 300-HW/D643:** 162 mm depth, accepts three (3) Full-size (gastronorm) pans and three (3) third-size (gastronorm) pans
- 300-HWI/D4:** 111mm depth, accepts three (3) Full-size (gastronorm) pans
- 300-HWI/D6:** 162 mm depth, accepts three (3) Full-size (gastronorm) pans
- 300-HWILF/D4:** 111mm depth, accepts three (3) Full-size (gastronorm) pans
- 300-HWILF/D6:** 162 mm depth, accepts three (3) Full-size (gastronorm) pans
- 300-HWI/D443:** 111mm depth, accepts three (3) Full-size (gastronorm) pans and three (3) third-size (gastronorm) pans
- 300-HWI/D643:** 162 mm depth, accepts three (3) Full-size (gastronorm) pans and three (3) third-size (gastronorm) pans

Factory-Installed Options

- Voltage Choices:
 - 120V
 - 208-240V
 - 230V
- Control Box Cord Location:
 - Back, Standard
 - Bottom, Option



W164 N9221 Water Street • P.O. Box 450 • Menomonee Falls, Wisconsin 53052-0450 • U.S.A.
 Phone: 262.251.3800 800.558.8744 U.S.A./CANADA Fax: 262.251.7067 800.329.8744 U.S.A. only
www.alto-shaam.com



Installation Requirements

- Appliance must be installed level and must not be installed in any area where it may be directly affected by steam, grease, dripping water, high temperatures, or any other severely adverse conditions.
- Some foods may require additional overhead heating. Always monitor the food temperature and add overhead heating when needed.
- Countertop material must withstand temperatures up to 200°F (93°C).
- A stainless steel heat shield is recommended if the area under the appliance is used for storage.

Clearance Requirements

1" (25mm) from combustible surfaces

Accessories

- Pan Divider Bar — half-size/third-size 11318
- Pan Divider Bar — full-size 16019
- Pan Divider Bar — D443/D643 size 1012405
- Locking Kit 5020849

300-HW Product/Pan Capacity*

D4: 72 lb (33 kg) / **D443:** 96 lbs (43.5 kg) Max.

Max. Volume: **D4:** 43.5 qt (42 L) / **D443:** 56.6 qt (53.3 L)

Full-Size Pans:	Three (3) 12" x 20" x 4" GN 1/1 (325mm x 530mm x 100mm)
Half-Size Pans:	Six (6) 12" x 10" x 4" GN 1/2 (325mm x 265mm x 100mm)
Third-Size Pans:	D4: Nine (9) / D443: Twelve (12) 12" x 6" x 4" GN 1/3 (325mm x 176mm x 100mm)

*Based on 4" (100mm) deep pans. Will also accept 2-1/2" (65mm) deep pans; D6 hot wells will accept 6" (150mm) deep pans.

300-HW Series

Hot Food Holding Drop-In Well

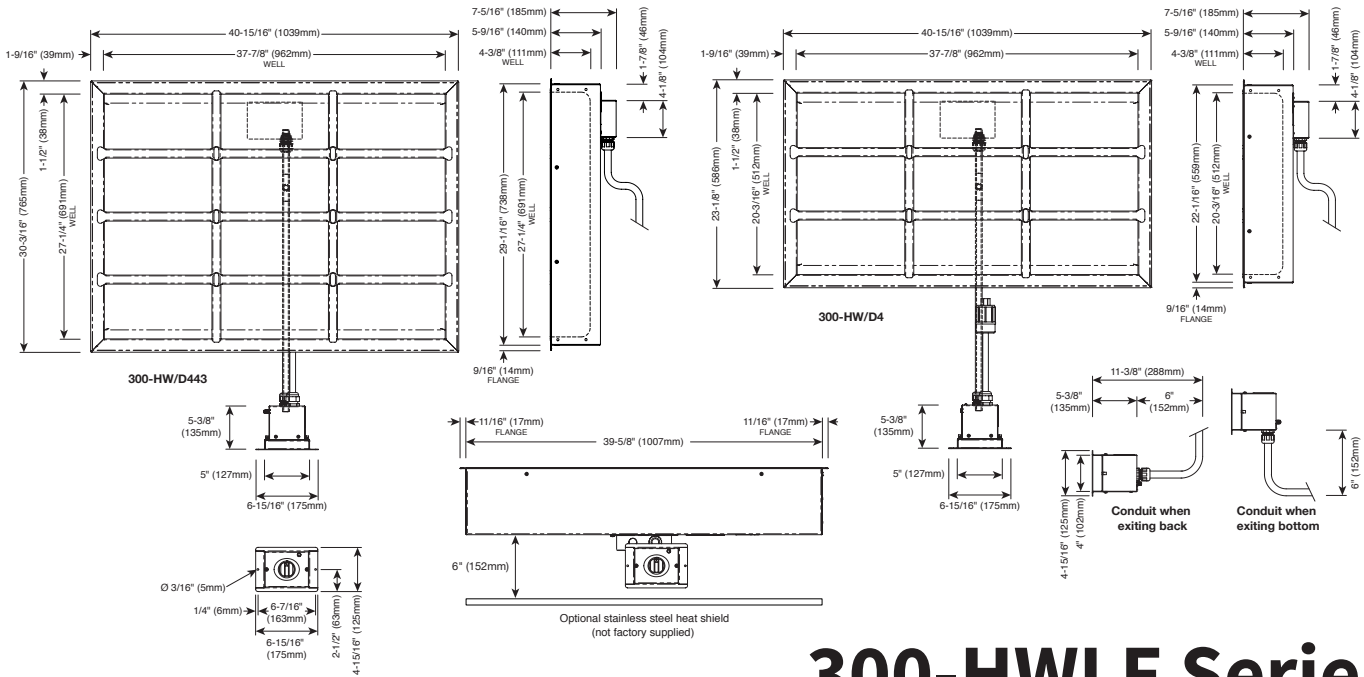

300-HWLF Series

Hot Food Holding Drop-In Well

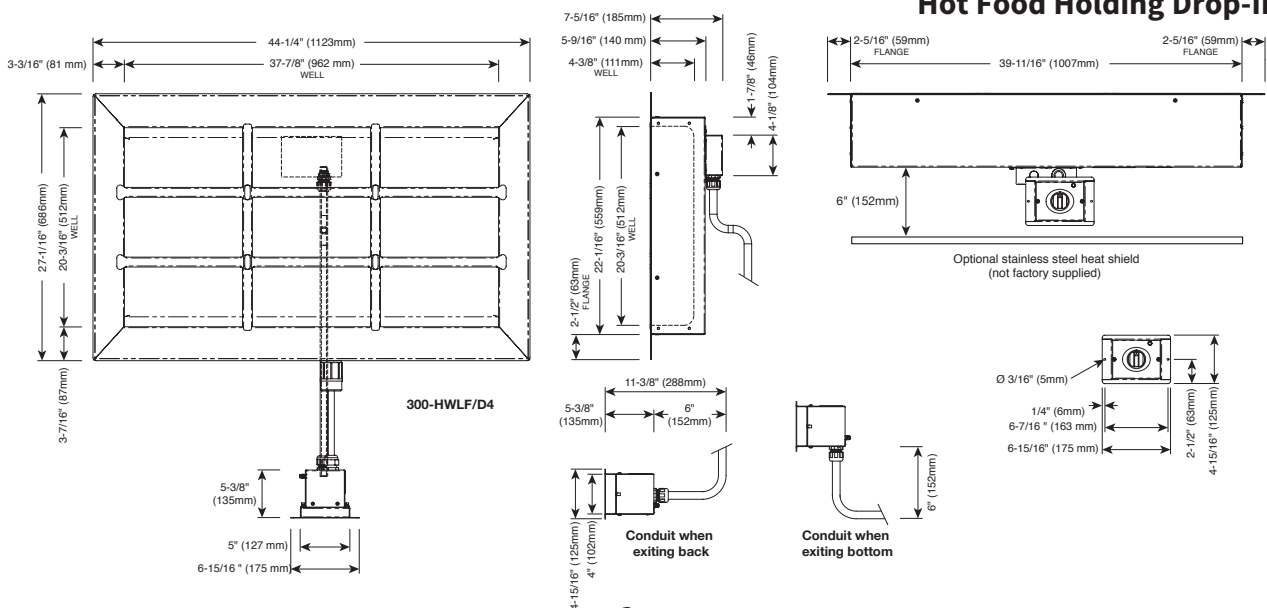

300-HWI Series

Hot Food Holding Drop-In Well

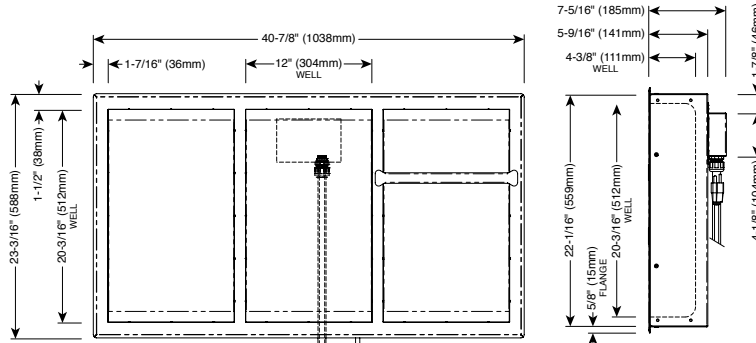

300-HWI/D4

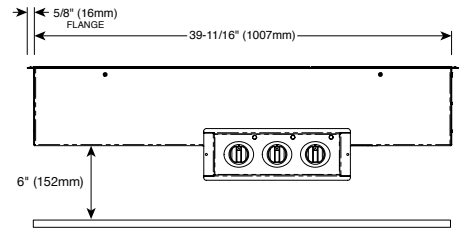
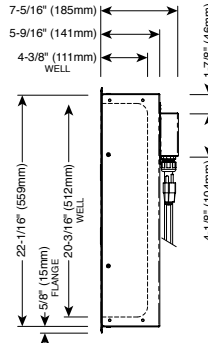
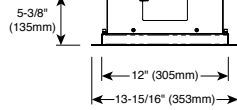

Optional stainless steel heat shield
(not factory supplied)

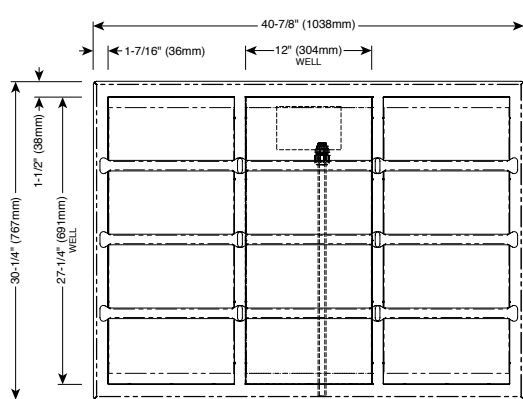
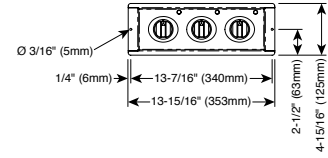

300-HWI/D443

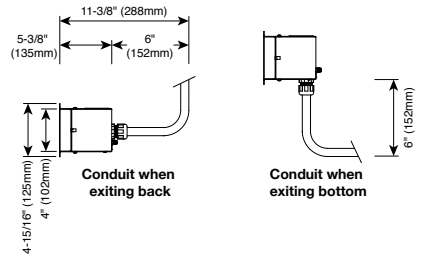
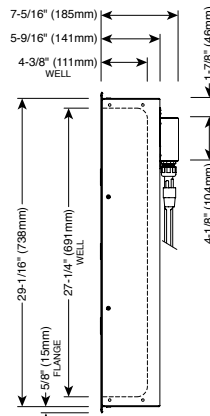
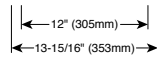

300-HWILF Series

Hot Food Holding Drop-In Well

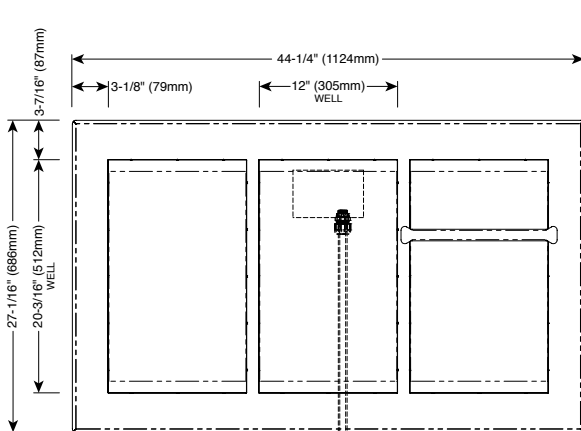

300-HWILF/D4

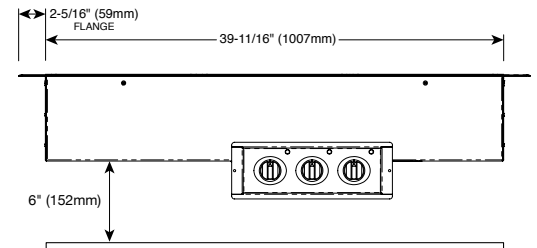
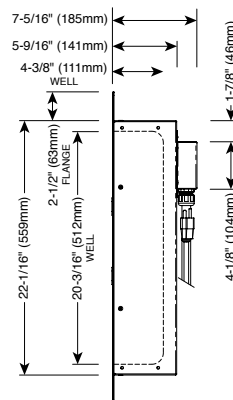
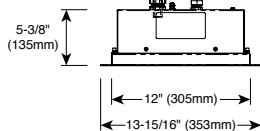

Optional stainless steel heat shield
(not factory supplied)

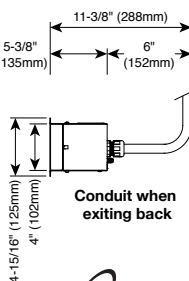
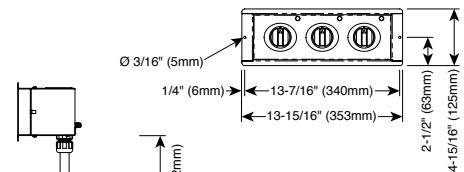

ALTO-SHAAM

Electrical						
	V	Ph	Hz	A	kw	Plug configuration
300-HW/D4 and /D6 300-HWLF/D4 and /D6 300-HWI/D4 and /D6 300-HWILF/D4 and /D6	120	1	50/60	15.0	1.8	NEMA 5-20P 20A - 125V plug
	208 - 240	1	50/60	6.5 - 7.5	1.4 - 1.8	NEMA 6-15P 15A - 250V plug
	230	1	50/60	7.8	1.8	CEE 7/7 Plug rated 250V CH2-16P Plug Rated 250V BS1363 Plug rated 250V
300-HW/D443 and /D643 300-HWI/D443 and /D643	120	1	50/60	20.3	2.4	NEMA L5-30P 30A - 125V plug
	208 - 240	1	50/60	8.8 - 10.1	1.8 - 2.4	NEMA 6-15P 15A - 250V plug
	230	1	50/60	10.6	2.4	CEE 7/7 Plug rated 250V CH2-16P Plug Rated 250V BS1363 Plug rated 250V

Cord Length: 120V - 6 ft. (1.8m) 208-240V - 9 ft. (2.7m) 230V (CEE) - 9 ft. (2.7m) 230V (CH, BS) - 8 ft. (2.5m)

Dimensions											
	Overall Exterior			Well Interior			Counter Cutout		Control Box Cutout*		
	Height	Width	Depth	Height	Width	Depth	Width	Depth	Height	Width	Depth
300-HW/D4	7-5/16" (185mm)	40-15/16" (1039mm)	23-1/8" (586mm)	4-3/8" (111mm)	37-7/8" (962mm)	20-3/16" (512mm)	40-1/4" (1022mm)	22-1/2" (559mm)	4-1/4" (108mm)	5-1/4" (133mm)	11-3/8" (288mm)
300-HW/D6	9-1/4" (234mm)	40-15/16" (1039mm)	23-1/8" (586mm)	6-3/8" (162mm)	37-7/8" (962mm)	20-3/16" (512mm)	40-1/4" (1022mm)	22-1/2" (559mm)	4-1/4" (108mm)	5-1/4" (133mm)	11-3/8" (288mm)
300-HW/D443	7-5/16" (185mm)	40-15/16" (1039mm)	30-3/16" (765mm)	4-3/8" (111mm)	37-7/8" (962mm)	27-1/4" (691mm)	40-1/4" (1022mm)	29-1/2" (749mm)	4-1/4" (108mm)	5-1/4" (133mm)	11-3/8" (288mm)
300-HW/D643	9-3/16" (233mm)	40-15/16" (1039mm)	30-3/16" (765mm)	6-3/8" (162mm)	37-7/8" (962mm)	27-1/4" (691mm)	40-1/4" (1022mm)	29-1/2" (749mm)	4-1/4" (108mm)	5-1/4" (133mm)	11-3/8" (288mm)
300-HWLF/D4	7-5/16" (185mm)	44-1/4" (1123mm)	27-1/16" (686mm)	4-3/8" (111mm)	37-7/8" (962mm)	20-3/16" (512mm)	40-1/4" (1022mm)	22-1/2" (559mm)	4-1/4" (108mm)	5-1/4" (133mm)	11-3/8" (288mm)
300-HWLF/D6	9-1/8" (232mm)	44-1/4" (1123mm)	27-1/16" (686mm)	6-3/8" (162mm)	37-7/8" (962mm)	20-3/16" (512mm)	40-1/4" (1022mm)	22-1/2" (559mm)	4-1/4" (108mm)	5-1/4" (133mm)	11-3/8" (288mm)
300-HWI/D4	7-5/16" (185mm)	40-7/8" (1038mm)	23-3/16" (588mm)	4-3/8" (111mm)	12" (304mm)	20-3/16" (512mm)	40-1/4" (1022mm)	22-1/2" (559mm)	4-1/4" (108mm)	12-1/4" (311mm)	11-3/8" (288mm)
300-HWI/D6	9-1/4" (234mm)	40-7/8" (1038mm)	23-3/16" (588mm)	6-3/8" (162mm)	12" (304mm)	20-3/16" (512mm)	40-1/4" (1022mm)	22-1/2" (559mm)	4-1/4" (108mm)	12-1/4" (311mm)	11-3/8" (288mm)
300-HWI/D443	7-5/16" (185mm)	40-7/8" (1038mm)	30-1/4" (767mm)	4-3/8" (111mm)	12" (304mm)	27-1/4" (691mm)	40-1/4" (1022mm)	29-1/2" (749mm)	4-1/4" (108mm)	12-1/4" (311mm)	11-3/8" (288mm)
300-HWI/D643	9-1/4" (234mm)	40-7/8" (1038mm)	30-1/4" (767mm)	6-3/8" (162mm)	12" (304mm)	27-1/4" (691mm)	40-1/4" (1022mm)	29-1/2" (749mm)	4-1/4" (108mm)	12-1/4" (311mm)	11-3/8" (288mm)
300-HWILF/D4	7-5/16" (185mm)	44-1/4" (1124mm)	27-1/16" (686mm)	4-3/8" (111mm)	12" (304mm)	20-3/16" (512mm)	40-1/4" (1022mm)	22-1/2" (559mm)	4-1/4" (108mm)	12-1/4" (311mm)	11-3/8" (288mm)
300-HWILF/D6	9-1/4" (234mm)	44-1/4" (1124mm)	27-1/16" (686mm)	6-3/8" (162mm)	12" (304mm)	20-3/16" (512mm)	40-1/4" (1022mm)	22-1/2" (559mm)	4-1/4" (108mm)	12-1/4" (311mm)	11-3/8" (288mm)

*Allow 6" (152mm) clearance from control box to conduit bend

Weight (est.)			
	Net Weight	Ship Weight*	Carton Dimensions* L X W X H
300-HW/D4	54.5 lb (25 kg)	128 lb (58 kg)	49" x 34" x 15" (1245mm x 864mm x 381mm)
300-HW/D6	61 lb (28 kg)	160 lb (73 kg)	49" x 34" x 15" (1245mm x 864mm x 381mm)
300-HW/D443	68 lb (31 kg)	128 lb (58 kg)	49" x 34" x 15" (1245mm x 864mm x 381mm)
300-HW/D643	75 lb (34 kg)	160 lb (73 kg)	49" x 34" x 15" (1245mm x 864mm x 381mm)
300-HWLF/D4	58 lb (26 kg)	contact factory	contact factory
300-HWLF/D6	64.5 lb (29 kg)	110 lb (50 kg)	49" x 34" x 15" (1245mm x 864mm x 381mm)
300-HWI/D4	69 lb (31 kg)	117 lb (53 kg)	49" x 34" x 15" (1245mm x 864mm x 381mm)
300-HWI/D6	77.5 lb (35 kg)	125 lb (57 kg)	49" x 34" x 15" (1245mm x 864mm x 381mm)
300-HWI/D443	85 lb (39 kg)	contact factory	contact factory
300-HWI/D643	99 lb (45 kg)	contact factory	contact factory
300-HWILF/D4	74 lb (34 kg)	135 lb (61 kg)	49" x 34" x 15" (1245mm x 864mm x 381mm)
300-HWILF/D6	83 lb (38 kg)	125 lb (57 kg)	49" x 34" x 15" (1245mm x 864mm x 381mm)

*Domestic ground shipping information. Contact factory for export weight and dimensions.

