



MODEL CTX4-10E WITH EXPRESS TOUCH CONTROL
CAPACITY OF FIVE (5) FULL-SIZE OR 65mm GN 1/1
PANS, TEN (10) FULL-SIZE 20mm DEEP GN 1/1 PANS,
OR TEN (10) HALF-SIZE SHEET PANS

- EcoSmart design uses less electricity than competitive models. The reduced energy setting further minimizes electricity use.
- Cooks with variable steam, convection heat, or a combination of both to roast, steam, bake, or oven-fry. Cooking speeds are increased by as much as 70% compared to conventional cooking methods.
- Cook with the optional product temperature probe or by time.
- Boiler-free, flash-steam generation increases reliability by eliminating boiler maintenance and boiler heating element burnout. The steam levels are maintained without a water reservoir.
- Two-speed reversing fan (ExpressTouch Control only) design provides excellent baking results and prevents excessive water and power consumption.
- Exclusive Gold-n-Brown™ feature on the ExpressTouch Control gives the operator the ability to achieve the ideal cooking environment for the ideal finish.
- Hand-held sprayer can be used to stop the cooking process in steaming vegetables, add water to your dishes, or rinse the inside oven cavity.
- Optional CombiSmoker® oven with smoking technology smokes any product, hot or cold, in the smallest footprint available.
- Optional broiler element revolutionizes the utilization of a multi-functional Combi to accommodate new recipe applications and entrée finishing [Patent Pending].
- CombiClean® tablet-based cleaning system with a choice of four (4) different levels of cleaning.

SHORT FORM SPEC

Alto-Shaam Combitherm® countertop Model CTX4-10E flash-steam electric CombiOven designed with EcoSmart® technology for reduced energy usage. The oven includes operational modes for steam, convection, and a combination of steam and convection heat. Standard features include: CombiClean® tablet-based cleaning system with a choice of four (4) different levels of cleaning, hand-held sprayer, positive action casual catch door handle, built-in

drip tray, and removable door gasket. Oven is constructed with stainless steel exteriors and stainless steel interior cavities. CombiOven includes cool-down function, and four (4) adjustable bullet legs. Each oven accommodates up to ten (10) half-size sheet pans or five (5) full-size hotel pans, and includes a standard right hinged door, ten (10) non-tilt support rails with 1-1/2" (38mm) vertical spacing between rails, and two (2) stainless steel shelves.

- ExpressTouch Control:** Includes two-speed reversing fan control, retherm mode, moisture injection, six (6) browning levels, reduced energy levels, steam venting, delayed start time, shelf timer, USB port, and software operation in English, French, German, Korean, Mandarin, Russian, and Spanish.
 - Single-point product temperature probe, Delta-T and cook & hold functionality (additional option)
 - Single-point product temperature probe, Delta-T and cook & hold functionality with HACCP data access (additional option)
 - CombiSmoker® smoking (additional option)
 - Broiler element — not available on 1ph units [Patent Pending] (reduces pan capacity by one (1)) (additional option)
- Simple Control:** Includes single-speed fan control
 - Single-point product temperature probe (additional option)

FACTORY INSTALLED

• Electrical Choices:

- 208V, 1ph
- 240V, 1ph
- 208-240V, 3ph
- 208-240V, 1ph
- 220-240V, 1ph
- 380-415V, 3ph

• Door Swing Choices:

- Right hinged, standard
- Left hinged, optional

• Leg Choices:

- 4" (102mm) bullet legs, 5014178, for countertop applications, standard
- 6" (152mm) bullet legs, 5014179, for floor standing applications, optional
- 6" (152mm) seismic legs, 5014734, for floor standing applications, optional [additional charge applies]
- Stacking Hardware, CTX4-10EC over CTX4-10E 67" x 23-3/8" x 37-3/16" (1701mm x 593mm x 945mm)

• Panel Color Choices:

- Stainless Steel, standard
- Black, optional
- Burgundy, optional
- Brown, optional
- Red, optional
- White, optional
- Custom Color, optional [longer lead time applies]
- Stacking Hardware, CTX4-10E over CTX4-10E 67" x 23-3/8" x 37-3/16" (1701mm x 593mm x 945mm)

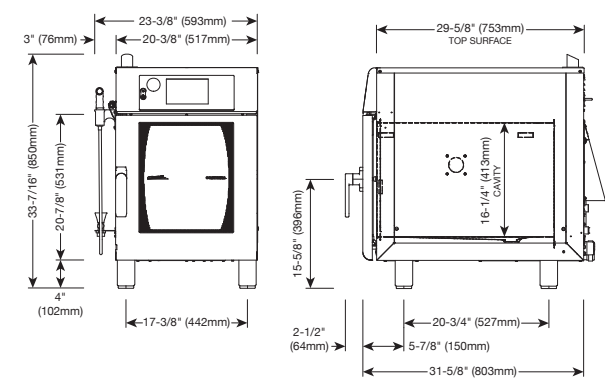
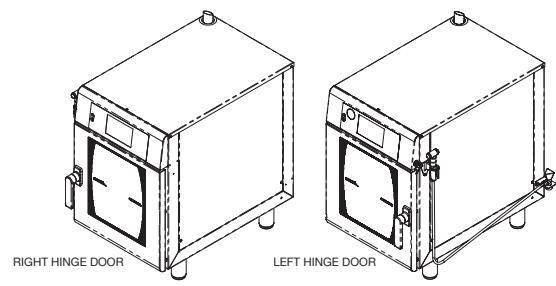
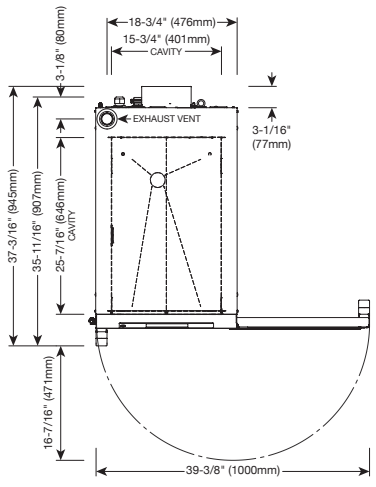

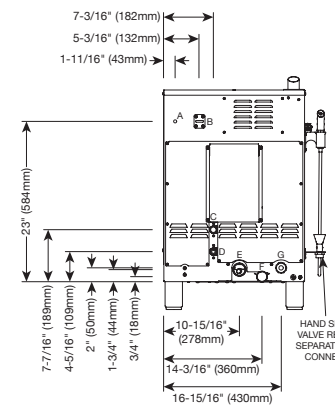

- A: HI-LIMIT RESET
- B: TETHER BRACKET REQUIRED FOR 380-415V, CASTER STAND, OR STACKING KITS
- C: TREATED WATER INLET
- D: UNTREATED WATER INLET
- E: 1-1/2" (38mm) DRAIN
- F: TANK CLEAN-OUT
- G: ELECTRICAL CONNECTION - CORD OR HARDWIRE



DIMENSIONS: H x W x D
EXTERIOR: 33-7/16" x 23-3/8" x 37-3/16" (850mm x 593mm x 945mm)

WATER REQUIREMENTS	
THREE (3) COLD WATER INLETS - DRINKING QUALITY	
ONE (1) TREATED WATER INLET: 3/4" G-style	
TWO (2) UNTREATED WATER INLET: (1) 3/4" G-style; (1) 3/4" GHT for hand-held sprayer	
LINE PRESSURE: 30 psi minimum dynamic and 90 psi maximum static (200 to 600 kPa)	
WATER DRAIN: 1-1/2" (40mm) CONNECTION WITH A VERTICAL VENT TO EXTEND ABOVE THE EXHAUST VENT. MATERIALS MUST WITHSTAND TEMPERATURES UP TO 200°F (93°C).	
CLEARANCE REQUIREMENTS	
LEFT: 4" (102mm)	18" (457mm) RECOMMENDED SERVICE ACCESS
RIGHT: 4" (102mm) NON-COMBUSTIBLE SURFACES	
TOP: 20" (508mm) FOR AIR MOVEMENT	
REAR: 4" (102mm)	BOTTOM: 4" (102mm) FOR AIR MOVEMENT
INSTALLATION REQUIREMENTS	
• Appliance must be installed level. • Hood installation is required.	
• Water supply shut-off valve and back-flow preventer when required by local code.	

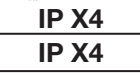
WATER QUALITY STANDARDS	
It is the sole responsibility of the owner/operator/purchaser of this equipment to verify that the incoming water supply is comprehensively tested and if required, a means of "water treatment" provided that would meet compliance requirements with the published water quality standards shown below. Non-compliance with these minimum standards will potentially damage this equipment and/or components and void the original equipment manufacturer's warranty. Alto-Shaam recommends using OptiPure® [www.optipurewater.com] products to properly treat your water.	
Contaminant	Inlet Water Requirements
Free Chlorine	Less than 0.1 ppm (mg/L)
Hardness	30-70 ppm
Chloride	Less than 30 ppm (mg/L)
pH	7.0 to 8.5
Silica	Less than 12 ppm (mg/L)
Total Dissolved Solids (tds)	50-125 ppm

ELECTRICAL (DEDICATED CIRCUIT REQUIRED) ⚡ GROUND FAULT OR RESIDUAL CURRENT PROTECTION DEVICE MUST ACCOMMODATE A LEAKAGE CURRENT OF 20mA							CombiSmoker®	Certification
VOLTAGE	PH	HZ	AMPS	kW	AWG	CORD & PLUG	Additional kW	
208	1	60	22.5	4.68	—	NEMA L6-30P - US ONLY	+ .52 kW	  IP X4 IP X4 IP X4 
240	1	60	25.5	6.12	8	NO CORD OR PLUG	+ .69 kW	
208-240	3	60	15.0-18.0	5.4-7.48	10	NO CORD OR PLUG	+ .69 kW	
208-240	1	50	22.5-25.5	4.68-6.12	—	8/3 CORD, NO PLUG	+ .69 kW	
220-240	1	50/60	24.0-25.5	5.28-6.41	8	NO CORD OR PLUG	+ .69 kW	
380-415	3	50/60	9.0-10.0	6.3-7.48	10	NO CORD OR PLUG	+ .69 kW	

WEIGHT			PAN CAPACITY			STANDARD MODEL		WITH COMBISMOKER® OPTION	
NET	180 lb EST	82 kg	FULL-SIZE:	20" x 12" x 2-1/2"	Five (5)†	Four (4)			
SHIP	310 lb*	141 kg*	GN 1/1:	530 x 325 x 65mm	Five (5)†	Four (4)			
			GN 1/1:	530 x 325 x 20mm	Ten (10)†	Eight (8)			
			**HALF-SIZE SHEET:	18" x 13" x 1"	Ten (10)†	Eight (8)			

SHIP DIMENSIONS			PRODUCT CAPACITY		
(L x W x H) 37" x 42" x 45"			PRODUCT MAXIMUM		48 lb (22 kg)
(940 x 1067 x 1143mm)*			VOLUME MAXIMUM		30 quarts (38 liters)

*DOMESTIC GROUND SHIPPING INFORMATION. CONTACT FACTORY FOR EXPORT WEIGHT AND DIMENSIONS. †CAPACITY WITHOUT BROILER ELEMENT OPTION

CTX4-10E COMBITHERM® CT Express™

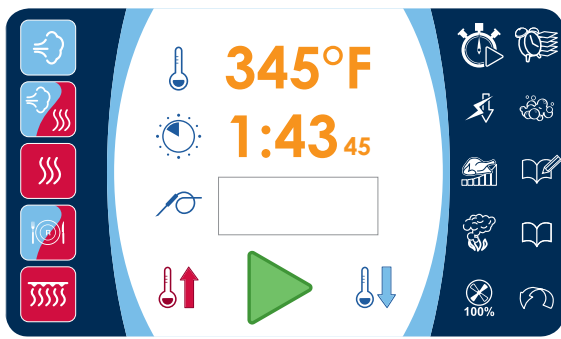

ExpressTouch with programmable control

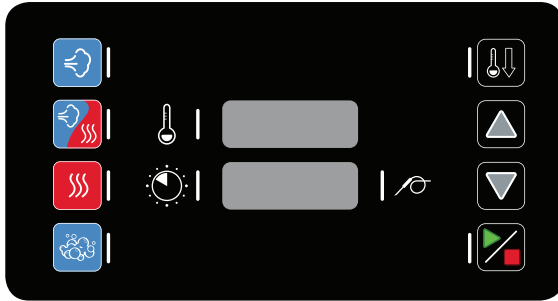

Simple with LED display



Steam Mode

- Automatic steaming at 212°F (100°C).
- Quick steaming at 213°F to 250°F (101°C to 121°C).
- Low temperature steaming for poaching or proofing.
85°F and 211°F (29°C and 99°C).



Combination Mode

- Combines steam and convection modes for faster production and better moisture retention.
- Improves yield, quality and shelf life.
- Automatic humidity control — 212°F to 485°F (100°C to 252°C).



Convection Mode

- Cooking, roasting, baking and finishing applications.
— 85°F to 485°F (29°C to 252°C).



Retherm Mode (ExpressTouch only)

- Bulk food or plated meal reheating with automatic steam injection.
— 245°F to 320°F (118°C to 160°C).
- Automatic humidity control.



Broiler Element (Optional on ExpressTouch only) [Patent Pending]

- Top heat element accommodates new recipe applications and entrée finishing.



Gold-n-Brown™ (ExpressTouch only)

- Gold-n-Brown vents just the right amount of humidity in the oven cavity for perfect browning. Six levels of Gold-n-Brown are featured.



Moisture Injection (ExpressTouch only)

- A quick burst of moisture can be added with a touch of a button at any time when cooking in the convection mode.



Automatic Time Delay (ExpressTouch only)

- Quick and simple method to begin preheating your oven while you're away, and ready to go when you are.



CombiSmoker® (Optional on Express Touch only)

- Smoke any product, hot or cold, utilizing real wood chips.
- Functions in both combination and convection mode.
- Sample bag of wood chips included.



HACCP Data Access (Optional on ExpressTouch only)

- Records cooking mode, time and temperature completed within a two week time period. The information is captured in a text format and can be downloaded to a USB device.

OPTIONS & ACCESSORIES	
<input type="checkbox"/> COMBITHERM CLEANING LIQUID — SPECIALLY FORMULATED FOR COMBITHERM OVENS ➔ TWELVE (12) CONTAINERS/CASE, 1 QUART (C. 1 LITER) EACH [SPECIAL HANDLING REQUIRED]	CE-24750
<input type="checkbox"/> COMBICLEAN® COMBITABS™ — SPECIALLY FORMULATED FOR COMBITHERM OVENS ➔ 90 (0.5 OUNCES) PACKETS EACH CONTAINER	CE-28892
<input type="checkbox"/> EXTENDED ONE-YEAR WARRANTY	CONTACT FACTORY
<input type="checkbox"/> FRY BASKET, 12" x 20" (325mm x 530mm)	BS-26730
<input type="checkbox"/> GRILLING GRATE, 12" x 20" (325mm x 530mm)	SH-26731
<input type="checkbox"/> POULTRY ROASTING RACK, 12" x 20" (325mm x 530mm) 6 CHICKEN CAPACITY — FITS INSIDE FULL-SIZE PAN: 1 RACK PER OVEN	SH-23000
<input type="checkbox"/> SCALE FREE™ (CITRUS BASED, NON-CORROSIVE DELIMING PRODUCT)	CE-27889
INSTALLATION OPTIONS	
<input type="checkbox"/> Alto-Shaam Combitherm Factory Authorized Installation Program - AVAILABLE IN THE U.S. AND CANADA ONLY	
<input type="checkbox"/> Installation Start-Up Check - AVAILABLE THROUGH AN ALTO-SHAAM AUTHORIZED SERVICE AGENCY	
<input type="checkbox"/> SHELF, STAINLESS STEEL WIRE, 12" x 20" (325mm x 530mm)	SH-2903
<input type="checkbox"/> STACKING KIT, MOUNTING ON TOP OF A 750-S, 750-TH-II, 750-TH/III, 1000-S, 1000-TH-II, OR 1000-TH/III	5019679
<input type="checkbox"/> STACKING KIT, MOUNTING ON TOP OF QUICKCHILLER™ QC2-3 OR QC2-20 WITHOUT BACKSPLASH	5015781
STAND, STAINLESS STEEL (H x W x D)	
<input type="checkbox"/> STATIONARY WITH DOUBLE SHELF, FOR SINGLE UNITS ONLY (HEIGHT WITH OVEN = 65-1/4" [1658mm]) 35-13/16" x 22-1/4" x 31-9/16" (910mm x 565mm x 802mm)	5014985
<input type="checkbox"/> MOBILE WITH SINGLE SHELF, FOR SINGLE UNITS ONLY (OVERALL HEIGHT WITHOUT HOOD = 47-3/4" [1213mm]) 18-5/16" x 21-3/4" x 31-1/16" (464mm x 552mm x 789mm)	5014738
<input type="checkbox"/> STATIONARY WITH SINGLE SHELF, IDEAL FOR TWO STACKED UNITS (OVERALL HEIGHT = 75-13/16" [1926mm]) 14-5/8" x 22-1/4" x 31-9/16" (371mm x 565mm x 802mm)	5014737
<input type="checkbox"/> STATIONARY WITH DOUBLE SHELF; LOWER SHELF TO HOLD 300-TH/III OR 300-S, (HEIGHT WITH OVEN = 77-1/4" [1962mm]) 35-13/16" x 23-3/4" x 31-9/16" (910mm x 603mm x 802mm)	5014986
WOOD CHIPS BULK PACK 20 lb (9 kg)	
<input type="checkbox"/> ➔ AppleWC-22543	<input type="checkbox"/> ➔ CherryWC-22541
<input type="checkbox"/> ➔ HickoryWC-2829	<input type="checkbox"/> ➔ MapleWC-22543



Fry Basket BS-26730



Grilling Grate SH-26731



Stacking Kit, QC2-3
5015781



Stacking Kit, QC2-20 without backsplash
5015781