



Outperform every day.™

Project:

Item Number:

Quantity:

# IMMERSION CIRCULATOR



40868



40861

Immersion Circulator

## MODELS

40868 Immersion Circulator (head only)

40861 Immersion Circulator (head, bath and cover)

## FEATURES

- Stainless steel housing for durability
- Temperature stability to 0.1°F (0.06°C) for precise, consistent results
- Two pump speeds for flexible cooking
- Three convenient programmable settings for ease of use
- Accurate LED Celsius or Fahrenheit temperature readouts for precise cooking
- 40861 includes a convenient factory fitted drain valve for easy cleaning
- When using Vollrath circulating head 40868 tank capacity must not exceed 7.9 gallons (30L)
- 6 ft. (1.8m) cord and plug

## DESCRIPTION

Sous Vide is a cooking method in which food is vacuum sealed in a plastic pouch and then cooked at a preset temperature in a water bath. This cooking method provides more control, and allows for perfect repeatable results.

### Agency Listings

#### Circulator Head



#### Water Bath and Cover



Due to continued product improvement, please consult [www.vollrath.com](http://www.vollrath.com) for current product specifications.

**WARRANTY:** All models shown come with Vollrath's standard warranty against defects in materials and workmanship. For full warranty details, please refer to the Vollrath Equipment and Smallwares Catalog.

Approvals	Date



Outperform every day.™  
[www.vollrath.com](http://www.vollrath.com)

The Vollrath Company, L.L.C.  
1236 North 18th Street  
Sheboygan, WI 53081-3201 U.S.A.  
Customer Service: 800.628.0830  
Canada Customer Service: 800.695.8560  
Main Fax: 800.752.5620 or 920.459.6573

Technical Services: 800.628.0832  
Technical Services Fax: 920.459.5462

# IMMERSION CIRCULATOR

**MODELS** 40868 Immersion Circulator (head only)  
 40861 Immersion Circulator (head, bath and cover)

## DIMENSIONS

• Dimensions shown in inches (cm).

### 40868

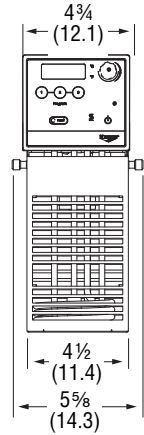

Front View

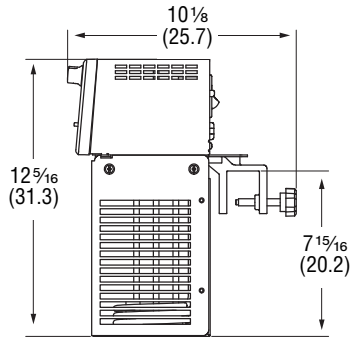

Side View

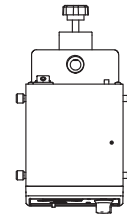

Top View

### 40861

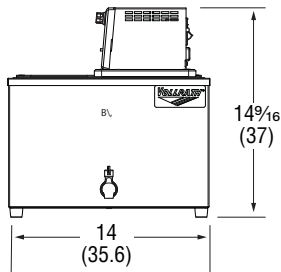

Front View

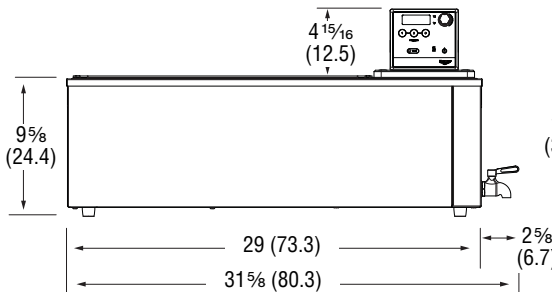

Side View

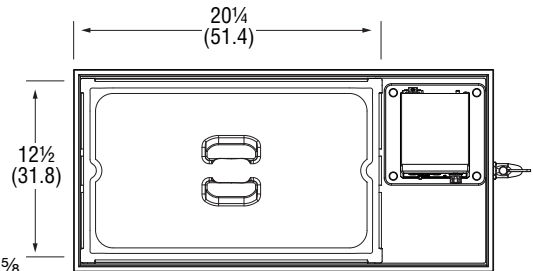

Top View

## SPECIFICATIONS

Model	Voltage	Watts	Amps	Plug	Shipping Container W x D x H	Shipping Weight LB (Kg)
40868	120V	1100	11	NEMA 5-15P	12 x 8 x 15 1/2 (30.5 x 20.3 x 39.4)	10 1/2 (4.8)
40861	120V	1100	11	NEMA 5-15P	18 5/8 x 33 3/8 x 13 3/4 (39.7 x 85.4 x 34.9)	49 (22.2)

### Receptacle

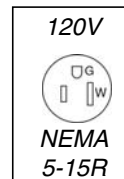

Outperform every day.™

www.vollrath.com

The Vollrath Company, L.L.C.  
 1236 North 18th Street  
 Sheboygan, WI 53081-3201 U.S.A.  
 Customer Service: 800.628.0830  
 Canada Customer Service: 800.695.8560  
 Main Fax: 800.752.5620 or 920.459.6573

Technical Services: 800.628.0832  
 Technical Services Fax: 920.459.5462