



# EQUIPMENT STAND

## SELF-CONTAINED REFRIGERATED BASE MODEL LPRES/RES

Self-contained refrigerated cooking equipment stand. Units are offered in a variety of lengths and capacities to meet your refrigerated storage needs on the cooking line. Stainless steel marine edge top supported by a 12 gauge sub-top provides heavy duty support for all cooking equipment. Electronically controlled refrigeration system provides precise temperature control to the cabinet. Heavy duty fully welded drawer cartridge assembly features a quick release system allowing drawers to be easily removed for cleaning. Standard 3 year warranty on the entire drawer system. Factory installed heavy duty casters are mounted to full length rails allowing for repositioning in the field.

**SHORT FORM SPEC:** Randell LPRES/RES series model refrigerated chef stand with electronically controlled natural R290 refrigeration system. Includes one-piece stainless steel 1/2" high single thickness marine top reinforced with 12 gauge steel sub-top. Drawers to be fully welded, cartridge assembly with quick release to allow easy removal of drawers without tools. Drawer system includes 3 year warranty on the entire assembly. Base interior constructed of anodized aluminum with coved corners, drawer opening frames shall be high impact ABS plastic and be cooled with a blower coil located behind the mullion. Drawers have stainless steel fronts with easy to grasp handles and press-fit magnetic gaskets. Unit to be shipped on heavy duty casters mounted to full length rails which allows casters to be relocated to avoid floor obstacles.

### AVAILABLE MODELS:

<b>4" Deep Pan Capacity:</b>	<b>6" Deep Pan Capacity:</b>
LPRES1x1-38C4	RES1x1-48C4
LPRES1x1-48C4	RES1x1-53C4
LPRES1x1-53C4	RES1x2-72C4
LPRES1x2-72C4	RES1x2-82C4
LPRES1x2-82C4	RES1x3-105C4
LPRES1x3-105C4	RES1x3-120C4
LPRES1x3-120C4	"x" denotes compressor location (right/left)

### STANDARD FEATURES:

- R-290 refrigeration system with visible externally mounted electronic controller to monitor temperature
- Foamed in place "CFC" free urethane insulation
- Marine edge stainless steel top with 12 gauge steel subtop to hold the heaviest cooking equipment (225 lbs/ft.)
- Heavy duty casters factory mounted to full length rails allow relocating casters to avoid floor obstacles
- Hinged compressor compartment panel for easy access to condenser coil cleaning
- 100% front breathing compressor housing allows sealing to wall and curb mounting without special requirements
- Drawer Cartridge Assemblies
  - 14 gauge tracks on 1-5/8" stainless steel bearings
  - Quick release drawers -removable without tools
  - Easy maintenance press-fit gaskets -removable without tools
  - 3 year warranty on entire drawer assembly

**REFRIGERATION SYSTEM:** All models will utilize state of the art, energy efficient R290 compressor systems with (0) ozone depletion (ODP) and (3) global warming potential (GWP). Temperature is managed by externally mounted visible electronic controller metered using capillary tube system. Mullion coil is coated to resist corrosion and offers maximum airflow for balanced temperature throughout the cabinet.

**CABINET EXTERIOR:** Cabinet body is constructed of all metal. The top, front, and louver panel are stainless steel. Full length, 12 gauge steel subtop beneath one piece stainless steel top with 1/2" high single thickness marine edge. Body ends are stainless steel. heavy duty casters (front locking) are mounted to full length heavy gauge steel rails integrally welded to bottom of assembly. Unit totally prewired to junction box. 9' cordset for 115V operation.

**CABINET INTERIOR:** Interior of cabinet is fully coved to meet NSF standards. The interior is constructed of anodized aluminum with coved corners for easy clean-up. Drawer opening frames are ABS and contain magnetic strip for positive seal of drawer gaskets. Unit insulated with CFC free, foamed in place polyurethane.

**REFRIGERATED DRAWERS:** Fully welded, unitized drawer cartridge assembly - patented. Heavy duty full extension 14 gauge drawer tracks on 1-5/8" heavy duty stainless steel bearings. Pans not included. Quick release allows drawers to be easily removed for cleaning. Stainless fronts, mounted to drawer cartridge assembly with easy to grasp drawer handles. Drawers with press fit magnetic gaskets - (designed for installation and removal without tools).

**ORIGIN OF MANUFACTURE:** Designed, tested and manufactured in the United States (MI, MS).

PROJECT NAME:	
LOCATION:	
ITEM NO:	
QTY:	
MODEL NO:	
AIA NO:	
SIS NO:	
CSI SECTION:	11400



Model LPRES1R2-72C4 shown

### OPTIONS/ACCESSORIES:

- Flat top
- 3-sided marine top (no turn up @ front)
- Dimension modification (consult factory)
- Legs in lieu of casters
- Curb mounting
- Door in lieu of drawers (19" & 27" only)
- Optional drawer size:
  - 19"
  - 44"

LPRES1R1-38C4

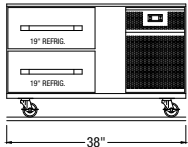
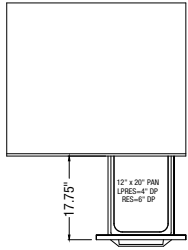

LPRES1R1-48C4  
RES1R1-48C4

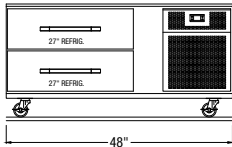
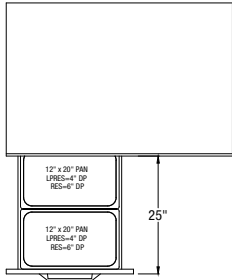

LPRES1R1-53C4  
RES1R1-53C4

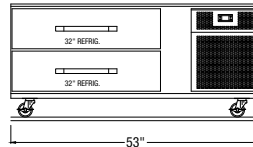
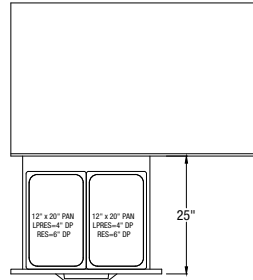

LPRES1R2-72C4  
RES1R2-72C4

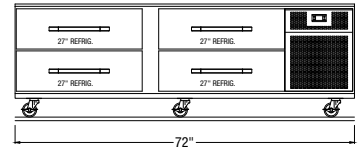
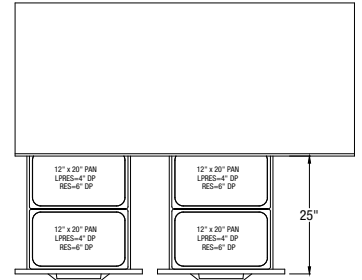

LPRES1R2-82C4  
RES1R2-82C4

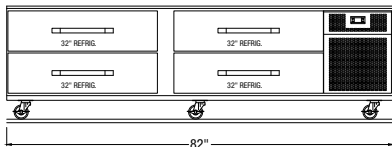
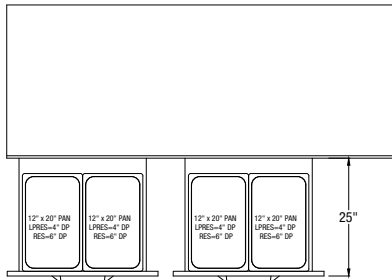

LPRES1R3-105C4  
RES1R3-105C4

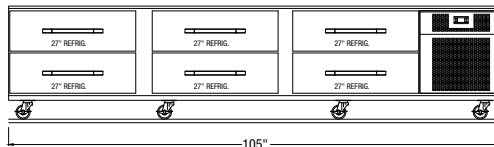
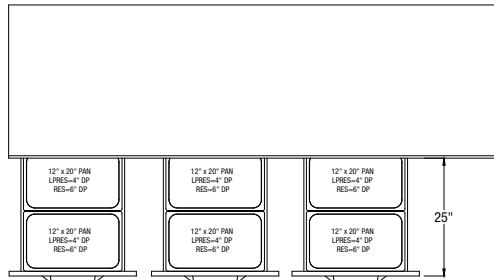

LPRES1R3-120C4  
RES1R3-120C4

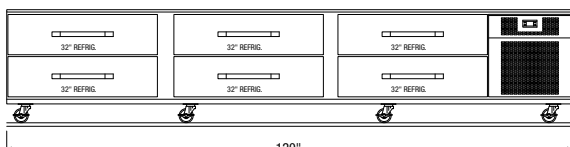
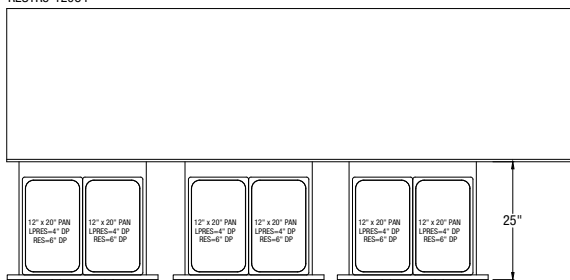

MODEL	COMPRESSOR LOCATION "x"	LENGTH	DEPTH	HEIGHT	PAN STORAGE CAPACITY	DRAWERS	HP	VOLT/CYCLE/ PHASE	AMPS	NEMA PLUG	SHIP WT.
<b>4" DEEP PAN CAPACITY</b>											
<b>LPRES1x1-38C4</b>	R=RIGHT, L=LEFT	38	32.5	23.5	(2) 12"x20"x4"	(2) 19"	0.25	115/60/1	6	5-15P	365
<b>LPRES1x1-48C4</b>	R=RIGHT, L=LEFT	48	32.5	23.5	(4) 12"x20"x4"	(2) 27"	0.25	115/60/1	6	5-15P	400
<b>LPRES1x1-53C4</b>	R=RIGHT, L=LEFT	53	32.5	23.5	(4) 12"x20"x4"	(2) 32"	0.25	115/60/1	6	5-15P	415
<b>LPRES1x2-72C4</b>	R=RIGHT, L=LEFT	72	32.5	23.5	(8) 12"x20"x4"	(4) 27"	0.25	115/60/1	6	5-15P	530
<b>LPRES1x2-82C4</b>	R=RIGHT, L=LEFT	82	32.5	23.5	(8) 12"x20"x4"	(4) 32"	0.25	115/60/1	6	5-15P	560
<b>LPRES1x3-105C4</b>	R=RIGHT, L=LEFT	105	32.5	23.5	(12) 12"x20"x4"	(6) 27"	0.33	115/60/1	7	5-15P	665
<b>LPRES1x3-120C4</b>	R=RIGHT, L=LEFT	120	32.5	23.5	(12) 12"x20"x4"	(6) 32"	0.33	115/60/1	7	5-15P	695
<b>6" DEEP PAN CAPACITY</b>											
<b>RES1x1-48C4</b>	R=RIGHT, L=LEFT	48	32.5	27.5	(4) 12"x20"x6"	(2) 27"	0.25	115/60/1	6	5-15P	410
<b>RES1x1-53C4</b>	R=RIGHT, L=LEFT	53	32.5	27.5	(4) 12"x20"x6"	(2) 32"	0.25	115/60/1	6	5-15P	425
<b>RES1x2-72C4</b>	R=RIGHT, L=LEFT	72	32.5	27.5	(8) 12"x20"x6"	(4) 27"	0.25	115/60/1	6	5-15P	545
<b>RES1x2-82C4</b>	R=RIGHT, L=LEFT	82	32.5	27.5	(8) 12"x20"x6"	(4) 32"	0.25	115/60/1	6	5-15P	575
<b>RES1x3-105C4</b>	R=RIGHT, L=LEFT	105	32.5	27.5	(12) 12"x20"x6"	(6) 27"	0.33	115/60/1	7	5-15P	685
<b>RES1x3-120C4</b>	R=RIGHT, L=LEFT	120	32.5	27.5	(12) 12"x20"x6"	(6) 32"	0.33	115/60/1	7	5-15P	715

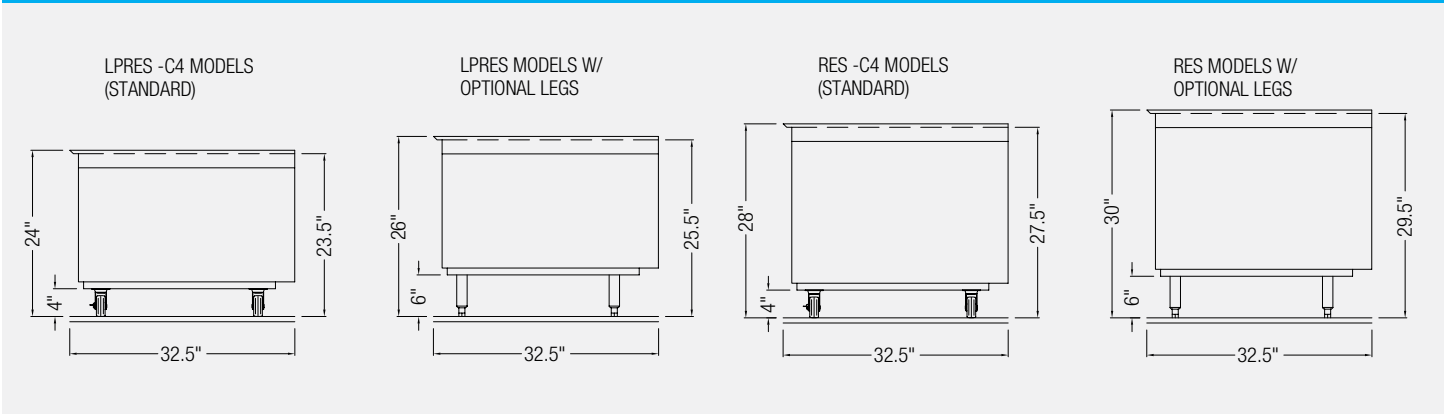
**DIMENSIONAL DETAIL:**

**DRAWERS:**



- Fully welded 14 gauge unitized Drawer Cartridge assembly
- Heavy-duty 14 gauge full extension drawer tracks on 1-5/8" heavy duty stainless steel bearings
- 3-year warranty on entire assembly
- Drawers with stainless steel drawer fronts and easy to grasp drawer handles
- Quick release allows drawers and cartridges, removable without tools

[See Video Demo of Drawer Removal Here](#)

**OPTIONAL DRAWERS:**

19" Drawer:

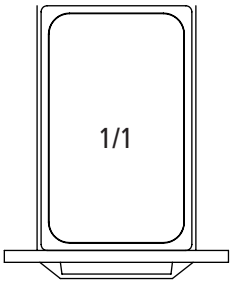

44" Drawer:

