

NOVA™ GLASS DOOR REFRIGERATORS



NR522

PROJECT:

ITEM NUMBER:

MODEL NUMBER:

1, 2 & 3 DOOR DISPLAY REFRIGERATORS

SPECIFICATIONS FOR: NR241SSG/0, NR522SSG/0 & NR803SSG/0

- **Exterior Finish:** Exterior front and sides are stainless steel. The exterior top, bottom and back are galvanized steel. All exterior joints and seams fold in without lap joints. No exposed raw edges.
- **Interior Finish:** Interior liner is stainless steel.
- **Insulation:** The complete cabinet is foamed-in-place with polyurethane insulation.
- **Hardware:** Heavy duty, pivot hinges with hold open devices; key locks; pull handles; self adjusting magnetic gaskets; 4" dia. casters (4 on one and two door models, 6 on three door models, with 2 locking) and three epoxy coated shelves per door section - standard
- **Glass Doors:** Each glass door provides 9.6 square feet of clear glass viewing space. Glass is tempered thermopane.
- **Electrical:** All models are standard with interior LED lighting activated by a manual switch.
- **Instrumentation:** Microprocessor control with integrated digital display.
- **Refrigeration:** Top mounted refrigeration system. A copper tube, aluminum fin evaporator. The condensate is collected and automatically evaporated from a hot gas vaporizer. Refrigerant flow is controlled by a capillary tube. R-134a refrigerant. Operating temperature: +38°F.
- **Approvals:** UL, C-UL and UL Sanitation listed**
DOE (Department of Energy) listed

STANDARD FEATURES

- Air-cooled condensing unit
- Automatic condensate evaporator
- Automatic defrost
- Capillary tube system
- Casters
- Digital thermometer
- Epoxy coated shelves
- Key locks
- LED lighting
- Magnetic gasketing
- Operating temperature: +38°F
- Polyurethane insulation
- Stainless steel interior and exterior
- Tempered glass
- Approvals: UL, C-UL & UL Sanitation** and DOE listed
- Warranties: 3 year parts and labor, 5 year compressor

OPTIONAL FEATURES*

- Alarm systems
- Expansion valve system
- Extra shelves
- Full door pan slides
- Half door pan slides
- Half glass doors
- Legs in lieu of casters
- Stainless steel backs
- Stainless steel shelves
- Temperature recorder



Nor-Lake, Inc.
 Registered to ISO 9001:2008
 File No. 10001816

* Most options are available two weeks from receipt of order. Please contact us for specific questions.
 **C-UL is Underwriters Laboratories Safety Certification Mark which indicates that UL has tested the equipment to applicable CSA Standards
 **UL Sanitation is Underwriters Laboratories Sanitation Mark which indicates that UL has tested the equipment to applicable NSF Standards.

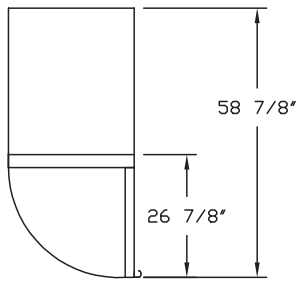

**NR241
TOP VIEW**

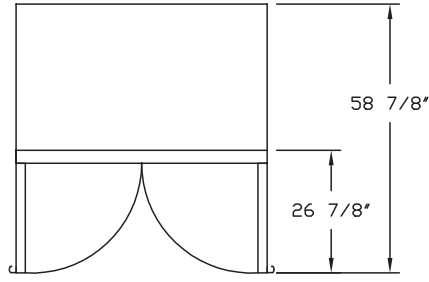

**NR522
TOP VIEW**

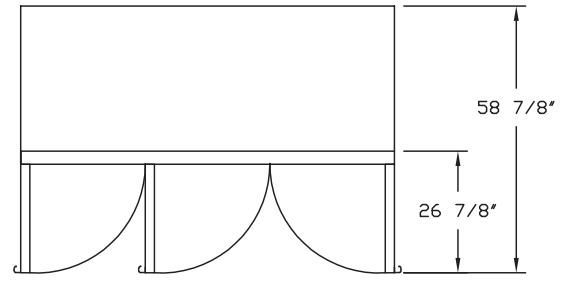

**NR803
TOP VIEW**

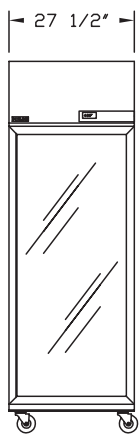

**NR241
FRONT VIEW**

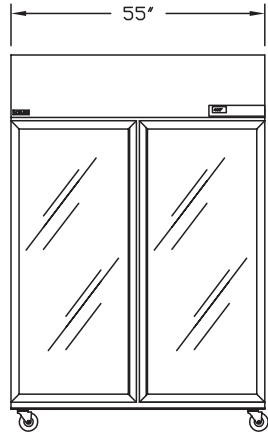

**NR522
FRONT VIEW**

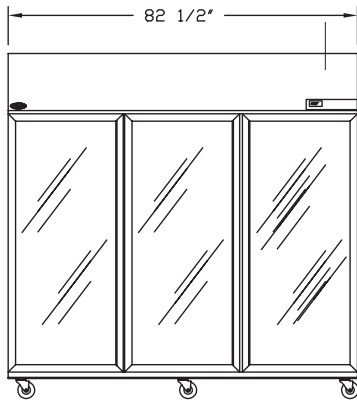

**NR803
FRONT VIEW**

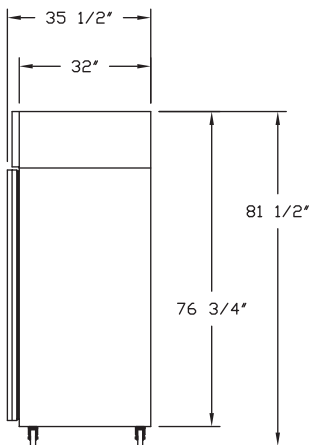

SIDE VIEW

SPECIFICATIONS

Models	NR241	NR522	NR803
<i>Crated Weight (lbs) (kg)</i>	365 (164)	545 (245)	750 (338)
<i>Crated Height (in) (cm)</i>	81 (203)	81 (203)	81 (203)
<i>Crated Width (in) (cm)</i>	31 (78)	59 (148)	86 (215)
<i>Crated Depth (in) (cm)</i>	38 (95)	38 (95)	38 (95)
<i>Interior Height (in) (cm)</i>	59 (148)	59 (148)	59 (148)
<i>Interior Width (in) (cm)</i>	23-1/2 (59)	51 (128)	78-1/2 (196)
<i>Interior Depth (in) (cm)</i>	30 (75)	30 (75)	30 (75)
<i>Overall Height (in) (cm) *</i>	81-1/2 (204)	81-1/2 (204)	81-1/2 (204)
<i>Overall Width (in) (cm)</i>	27-1/2 (69)	55 (138)	82-1/2 (206)
<i>Overall Depth (in) (cm)</i>	35-1/2 (88)	35-1/2 (88)	35-1/2 (88)
<i>Gross Cubage (CuFt) (L)</i>	24.0 (679)	52.0 (1472)	80.0 (2264)
<i>Shelf Area (SqFt) (Sqm)</i>	12.8 (1.17)	28.6 (2.63)	42.9 (3.94)
<i>Glass Area (SqFt) (Sqm)</i>	9.6 (.88)	19.3 (1.78)	28.9 (2.66)
<i>Number of Shelves</i>	3	6	9
<i>Number of Casters</i>	4	4	6
<i>Number of Legs (Optional)</i>	4	4	6
<i>Condensing Unit Size</i>	1/4 HP	1/3 HP	1/2 HP
<i>Refrigerant</i>	R-134a	R-134a	R-134a
<i>Electrical Characteristics</i>	115/60/1	115/60/1	115/60/1
<i>Cord & Plug Furnished</i>	Yes	Yes	Yes
<i>NEMA Plug Configuration</i>	5-15P	5-15P	5-15P
<i>Total Amp Draw</i>	4.9	8.0	9.1

* The overall heights shown in the table and drawings are with casters. With optional 6' legs, the overall height is 82-3/4 inches (207 cm).

Specifications subject to change without notice.



Revision Date: 08/13
© 2013 NOR-LAKE, INC.
Printed in the U.S.A.
Part Number: 040344