

iT0620 Ice Cube Machine

Models

- IRT0620A
 IDT0620A
 IYT0620A
 IDT0620W
 IYT0620W



Indigo NXT Series iT0620 Ice Machine on D420 Bin

Designed for operators who know that ice is critical to their business, the Indigo NXT Series ice machine's preventative diagnostics continually monitor itself for reliable ice production. Improvements in cleanability and programmability make your ice machine easy to own and less expensive to operate.

- **New levels of Performance** – Showcasing an average of 31% lower energy consumption, 16% reduction in in potable water usage and a 32% reduction in condenser water usage. This translates into lower cost of ownership over the life of your machine.
- **easyTouch[®] Display** - New icon based touch screen takes the guess work out of owning and operating an ice machine.
- **Programmable Ice Production** – Now its super easy to program your ice machine to be off at certain times of the day to save money with fluctuating electrical rates. Also programmable by daily ice production volume.
- **Easy to Clean Foodzone** – Hinge front door swing out for easy access. Removable water-trough, distribution tube, curtain, water probe and water pump for fast and efficient cleaning. Selected components are made with AlphaSan[®] antimicrobial.
- **Intelligent Diagnostics** – Provides 24 hour preventative maintenance and diagnostic feedback for trouble free operation.
- **Acoustical Ice Sensing Probe** – Unique patented technology allows for reliable operation in challenging water conditions and environments
- **DuraTech[®] Exterior** – Provides superior corrosion resistant above stainless steel. Innovative clear-coat resists fingerprints and dirt making it easier to keep clean.
- Available **LuminIce[®] II Growth Inhibitor** – Controls the growth of bacteria and yeast within the Food zone keeping the machine cleaner longer. A new indicator in the display keeps you abreast of the operational status.

Ice Machine Electric

115/60/1 standard
(208-230/60/1 also available)

Minimum circuit ampacity:

Air-cooled: 12.2, 115v 5.9, 208-230V
Water-cooled: 11.6,-115v, 5.6,-208-230v

Maximum fuse size:

Air-cooled: 20A for 115v, 15A for 208-230v
Water-cooled: 20A, 115v and 15A, 208-230v



Specifications

BTU Per Hour:
5,400 (average),
and 6,300 (peak)

Refrigerant:

R410A CFS - Free
Lowers global warming
by 48%

Operating Limits:

- Ambient Temperature Range: 40° to 110°F (4.4° to 43.3° C)
Water Temperature Range: 40° to 90°F (4.4° to 32.2° C)
- Water Pressure Ice Maker Water In:
Min. 20 psi (137.9 kPa)
Max. 80 psi (551.1 kPa)

Ice Shape

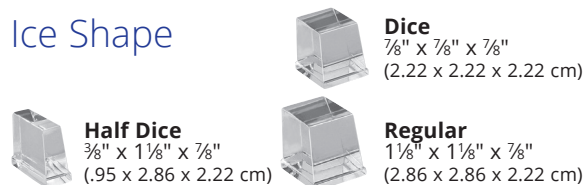

COMPANY WITH QUALITY SYSTEM



iT0620 on D420 Storage Bin

- (A) Electrical Entrance (2) Options
- (B) 3/8" (0.95 cm) F.P.T. Water Condenser Inlet (water-cooled units)
- (C) 1/2" (1.27 cm) F.P.T. Water Condenser Outlet (water-cooled units)
- (D) 1/2" (1.27 cm) Auxillary Base Drain Socket
- (E) 3/8" (0.95 cm) F.P.T. Ice Making Water Inlet
- (F) 1/2" (1.27 cm) F.P.T. Ice Making Water Drain
- (G) 3/4" (1.91 cm) Bin Drain

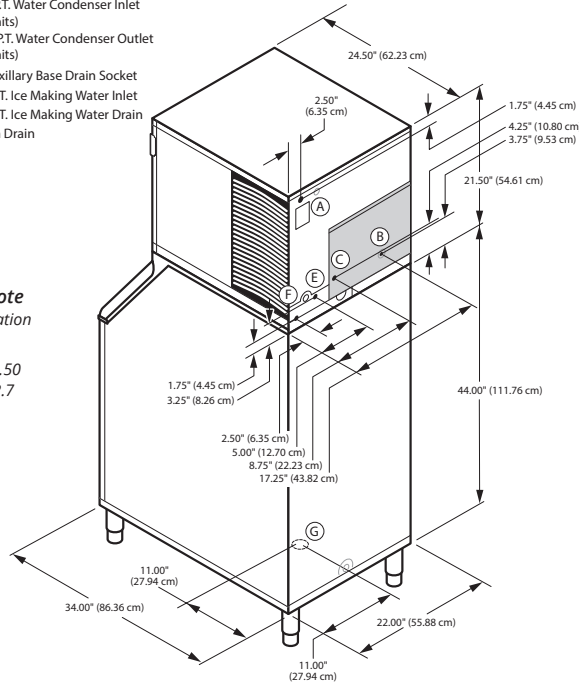

Installation Note
Minimum installation clearance:
Top/side: 12" (30.50 cm)
Back is 5" (12.7 cm)

Space-Saving Design



	iT0620 D-400	iT0620 D-420
Height	59.50" 151.13 cm	71.50" 181.61 cm
Width	30.00" 76.20 cm	22.00" 55.88 cm
Depth	34.00" 86.30 cm	34.00" 86.30 cm
Bin	365 lbs.	383 lbs.
Storage	166 kgs.	174 kgs.

Height includes adjustable bin legs 6.00" to 8.00", (15.24 to 20.32 cm) set at 6.00" (15.24 cm).
Bin capacity is based on 90% of the volume x 33 lbs/ft³ average density of ice.
K00443 bin adapter required for D400 bin. Sold separately

Specifications

	Model	Ice Shape	Ice Production 24 Hours		Power Usage kWh/100 lbs. @90°Air/70°F	Potable Water Usage/100 lbs. 45.4 kgs. of Ice
			70°Air/ 50°F Water	90°Air/ 70°F Water		
AIR COOLED	IRT0620A	regular	525 lbs.	410 lbs.	5.29	19.9 Gal.
			238 kgs	186 kgs		75.3 L
	IDT0620A	dice	560 lbs.	450 lbs.	5.18 ★	19.9 Gal.
WATER COOLED	IYT0620A	half-dice	254 kgs	204 kgs	4.87 ★	75.3 L
			575 lbs.	465 lbs.		19.9 Gal.
	IDT0620W	dice	261 kgs	211 kgs	4.13	75.3 L
			530 lbs.	450 lbs.		19.9 Gal.
	IYT0620W	half-dice	240 kgs	204 kgs	3.87	75.3 L
560 lbs.	485 lbs.	19.9 Gal.				
			254 kgs.	220 kgs		75.3 L

* Water-cooled Condenser Water Usage / 100 lbs. /45.4 kgs. Of Ice: 140 gal/ 530 L.

*Water-cooled models are excluded from ENERGY STAR qualification.

Order separately: Ice storage bin for all units
★ENERGY STAR® 3.0

Accessories

LuminIce® II Growth Inhibitor
reduces yeast and bacteria growth for a cleaner ice machine.



External Scoop holder
Protect the ice scoop with the NSF approved versatile scoop holder.

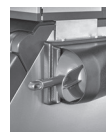

Arctic Pure® Water Filters
Reduces sediment and chlorine odors for better tasting ice.



iAuCS®
schedules and performs routine ice machine cleaning automatically.



Welbilt reserves the right to make changes to the design or specifications without prior notice.



Ice Storage Bins

Model

- D320
 D400
 D420
 D570
 D970

D Bins

.75" (1.90 cm) Bin drain

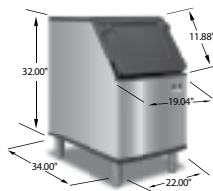

D320
210 lbs. (95 kgs)

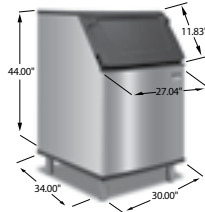

D570
430 lbs. (195 kgs)

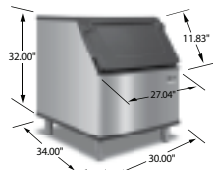

D400
290 lbs. (132 kgs)

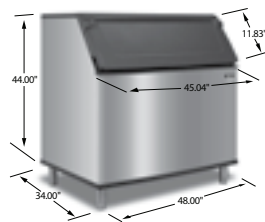

D420
310 lbs. (141 kgs)

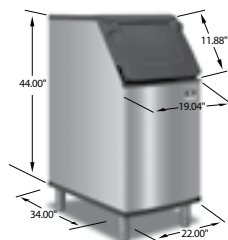

D970
710 lbs. (323 kgs)



Ergonomic NSF approved sanitary ice scoop included

D Bin Features

New Sanitary Scoop Ergonomic NSF approved sanitary ice scoop included with each bin. Built-in knuckle and thumb guard. Unique molded retaining lip allows maximum scooping every time. Per scoop capacity approximately 5.3/ lbs (2.4 kg)

Scoop Holder options New built-in scoop holder, keeps the ice scoop handle above the ice, or purchases the optional NSF approved External Scoop Holder Kit # K00461. (Available January 2018)

New Door design Clever built in side grips allow you to lift the bin door from anywhere you are standing (left, right or center) even when you have just one hand free.

Foamed Insulated Door

Insulates the ice bin, reduces sweat on the door, helps keep ice lasting longer.

Stay up door Unique cammed bin door self-latch keeps the door in the open position and keeps the employee safe when scooping ice.

Ergonomic Door design Door is angled 53 degrees to allow for easier access to the ice in the bin especially when scooping from the bottom.

Duratech Metal Finish Manitowoc exterior material has better corrosion resistance than stainless steel, is smudge resistant and easy to keep clean.

New Bin liner Polyurethane Artic Blue bin liner accentuates the crisp clear ice from a Manitowoc Ice Machine.

Warranty

Bin & Accessories: 3 Year Parts & Labor.

D Bin Model	D-Bin Capacities						D-Bin Dimensions					
	*Application Capacity		**2017 AHRI Capacity		**2018 AHRI Capacity		Height		Width		Depth	
	lbs.	kgs.	lbs.	kgs.	Cu. ft	Cu. M	in.	cm	in.	cm	in.	cm
D320	264	119.90	210	95.25	8.9	0.25	38	96.5	22	55.9	34	86.4
D420	383	173.79	310	140.61	12.9	0.37	50	127	22	55.9	34	86.4
D400	365	165.70	290	131.54	12.3	0.35	38	96.5	30	76.2	34	86.4
D570	532	241.14	430	195.05	17.9	0.51	50	127	30	76.2	34	86.4
D970	882	400.11	710	322.05	29.7	0.84	50	127	48	121.9	34	86.4

*Application Capacity is based on 90% of the volume x 33 lbs/ft³ average density of ice. Ice must be managed
 **2017 Approved AHRI capacity is based on 80% of the total volume x 30 lbs/ft³ average density of ice
 ***2018 AHRI certified measurement for bin capacity

Above bin heights include leg height of 6" / 15.24 cm
 All bins include sanitary plastic ice scoop and one set of adjustable (6 in to 7.75 in / 15.24 to 20.32 cm) chrome legs
 External Scoop holder order separately Kit # 000461



Welbilt reserves the right to make changes to the design or specifications without prior notice.



D Bins

Indigo Ice Machines Series												
Machine			iT420	iT620	i300	iT450	iT500	iF600, iF600C	iF900, iF900C	iT1200, iT1200C	iF1400C iF1800C iF2100C	iT1500, iT1900
Machine Capacity @90/70 F			375	465	240	378	440	555, 530	710, 714	950, 1000	1200 1470 1600	1360, 1455
Bins	Bin Cap	Width	22"	22"	30"	30"	30"	30"	30"	30"	30"	48"
D320	264	22"	*	*								
D420	383	22"	*	*								
D400	365	30"	K00472	K00472	*	*	*	*	NR	NR	NR	
D570	532	30"	K00472	K00472	*	*	*	*	*	*	NR	
D970	882	48"	NR	NR	NR	K00470	K00470	K00470	K00470	K00470	K00471 + K00470	*

Manitowoc Flaker and Nugget Machines											
Machine			RNS0308 & RNF320	RF50300 &RFF320	RNF620	RFF0620	RNF1020	RFF1220	RNF1100	RFF1300	RFF2200C
Machine cap			251	286	451	540	825	958	825	874	1702
Bins	Bin cap	Width	22"	22"	22"	22"	22"	22"	30"	30"	36.7"
D320	264	22"	*	*	NR	NR	NR	NR			
D420	383	22"	*	*	*	*	NR	NR			
D400	365	30"	K00472	K00472	K00472	K00472	NR	NR	NR	NR	
D570	532	30"	NR	K00472	K00472	K00472	NR	NR	*	*	
D970	882	48"	NR	NR	K00473	K00473	K00473 if 2 used.	K00473 if 2 used.	K00470	K00470	K00470

An optional adapter is required when putting a narrower ice machine on a wider bin.

* No adapter is needed

NR= Not Recommend. Bin too small or too large for application.

Putting a wider machine on narrower bin is not an option.

Machines side by side must be water cooled or remote.

Application Bin Capacity shown in lbs using the AHRI rating based on 90% of total volume x 33 lbs/ft³ average density of ice.

Machine capacity shown in lbs/24hrs using the AHRI rating base at 90F ambient, 70F water temperature

Ice Storage Bins

Available Accessories See price book for replacement: scoops, legs, specialty legs and casters

K00146 Convenient Ice Bagger

Includes bagger, D-bin adapter, and 250 bags and ties (Not for D320 or D400) Order K00068 replacement bags



K00461 External Scoop Holder

NSF approved. Can be mounted on the left or right side of bins, horizontally or vertically or on a wall.



K00463 Metal Scoop

Indestructible NFS approved aluminum alloy with sanitary knuckle and thumb guard. Works with K00461 external scoop holder or hangs inside the D-Bin series. Limited life time guarantee. (Available October 2018)



K00462 Secure Fastening Kit

Securely fast the Indigo[®] ice machine head to the pre-drilled inserts on the back of the D-bin series. Stainless steel flanged feet attach to bin and can be screwed to the floor



Welbilt reserves the right to make changes to the design or specifications without prior notice.