

Project \_\_\_\_\_  
 Item \_\_\_\_\_  
 Quantity \_\_\_\_\_  
 CSI Section 11400  
 Approved \_\_\_\_\_  
 Date \_\_\_\_\_

RNF-0620

# RNF-0620

## NUGGET ICE MACH

### Model

- RNF-0620A     RNF-0620W



RNF-0620A Nugget Ice Machine on Multiplex SV-250 Dispenser

Model RNF-0620A Nugget Ice Machine on D-420 Bin

### Features

- Bite sized nugget with 85% ice content offers one of the best ice to water ratios for maximum cooling and minimal drink dilution
- Up to 613 lbs. (278 kg) of daily ice production
- Perfect for beverage applications, dispensing, smoothies, and cold therapy
- Can be paired with a Multiplex beverage dispenser for an unbeatable soft drink experience
- Highload maintenance free bearings for enhanced reliability
- Evaporator is designed for maximum quality and operating life



### Specifications

- BTU per hour:**  
 5,200 (average)  
 7,700 (peak)
- Compressor:**  
 Nominal rating: 1 HP
- Refrigerant:**  
 R-404A
- Operating Limits:**
- Ambient Temperature Range: 50° -110 °F (10° -43 °C)
  - Water Temperature Range: 37° -90 °F (3° -32 °C)
  - Water Pressure Ice Maker Water In: Min. 14 psi (96.5 kPa) Max. 80 psi (551.1 kPa)

### Ice Machine Electric

- 115/60/1 standard. (230/50/1 also available.)
- Minimum circuit ampacity:**  
 Air-Cooled: 16.3  
 Water-Cooled: 15.4
- Maximum fuse size:**  
 Air-Cooled: 25 amps  
 Water-Cooled: 25 amps
- HACR-type circuit breakers can be used in place of fuses.

### Ice Shape

Nugget ice consists of small pieces ranging from 3/8" to 1/2" in width and length on average. Offers a 85% ice to water ratio with a soft, chewable texture while still providing maximum cooling effect and great dispensibility.



Ice shown actual size



### RNF-0620 on D-420 Storage Bin

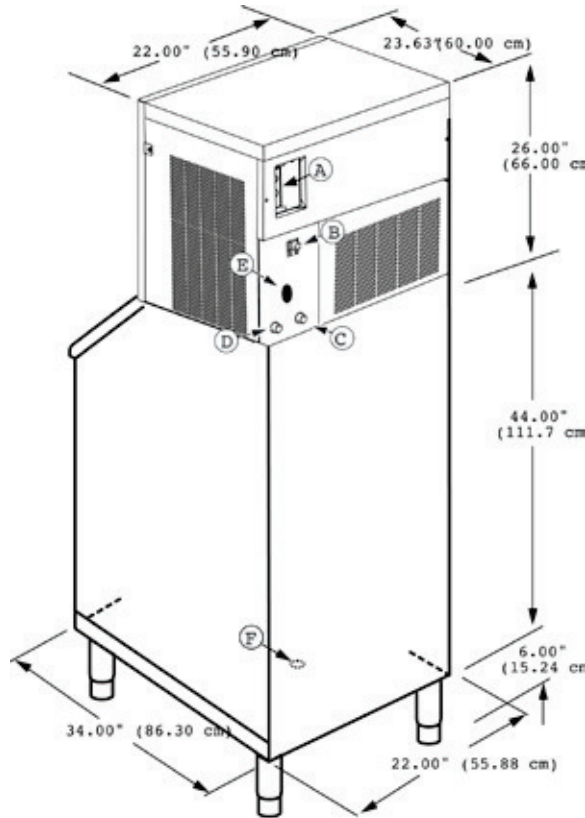

**Dispenser Note -**  
Verify with the dispenser manufacturer that the correct agitator and deflector kit for nugget ice dispensing is included with your dispenser purchase.

**Installation Note -**  
Minimum installation clearance:  
Top/sides: 8" (20.32 cm),  
Back: 5" (12.70 cm).

- A Electrical Entrance (2) Options
- B 3/8" FF Condenser Inlet (water-cooled only)
- C 1/2" NF Condenser Drain (water-cooled only)
- D 1/2" NF Hot Making Water Drain
- E 3/8" FF Hot Making Water Inlet
- F 3/4" Bin Inlet

### Space-Saving Designs



RNF-0620 on D-420	
Height	76.00" / 193.00 cm
Width	22.00" / 55.90 cm
Depth	34.00" / 86.36 cm
Bin Storage	310 lbs / 140.7 kg

Height includes adjustable bin legs 6.00" to 7.00", (15.24 to 17.78 cm) set at 6.00" (15.24 cm).

### Accessories

K-00443 30" D Style Bin Adapter

#### Air Flow Overhead View

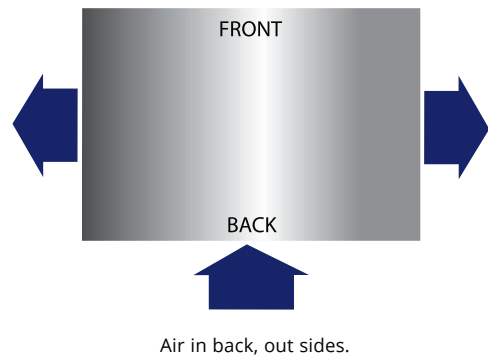

RNF-0620

	Model	Ice Shape	Ice Production 24 Hours		Power kWh/100 lbs @ 90°Air/70°F	Water Usage (100 lbs./45.4 kgs of Ice)	
			70° Air/50°F Water 21° Air/10° C Water	90° Air/70°F Water 32° Air/21° C Water		Potable Water	Condenser Water
AIR-COOLED	RNF-0620A	Nugget	Standard	Standard	6.36	12 gal	—
			268 kg	204 kg		45.4 L	—
WATER-COOLED	RNF-0620W	Nugget	Standard	Standard	4.67	12 gal	118 gal
			278 kg	230 kg		45.4 L	447 L

Welbilt reserves the right to make changes to the design or specifications without prior notice.



# Ice Storage Bins

## Model

- D320  
  D400  
  D420  
  D570  
  D970

## D Bins

.75" (1.90 cm) Bin drain

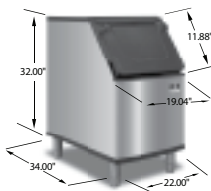

D320  
210 lbs. (95 kgs)

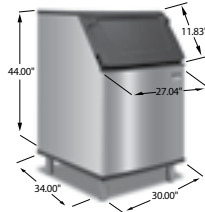

D570  
430 lbs. (195 kgs)

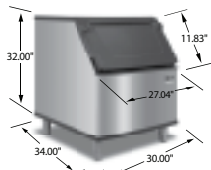

D400  
290 lbs. (132 kgs)

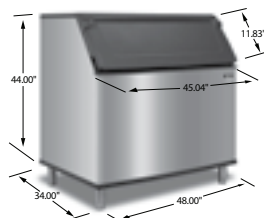

D420  
310 lbs. (141 kgs)

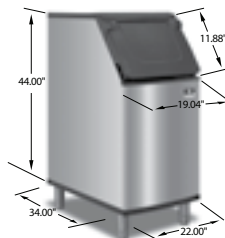

D970  
710 lbs. (323 kgs)



Ergonomic NSF approved sanitary ice scoop included

## D Bin Features

**New Sanitary Scoop** Ergonomic NSF approved sanitary ice scoop included with each bin. Built-in knuckle and thumb guard. Unique molded retaining lip allows maximum scooping every time. Per scoop capacity approximately 5.3/ lbs (2.4 kg)

**Scoop Holder options** New built-in scoop holder, keeps the ice scoop handle above the ice, or purchases the optional NSF approved External Scoop Holder Kit # K00461. (Available January 2018)

**New Door design** Clever built in side grips allow you to lift the bin door from anywhere you are standing (left, right or center) even when you have just one hand free.

### Foamed Insulated Door

Insulates the ice bin, reduces sweat on the door, helps keep ice lasting longer.

**Stay up door** Unique cammed bin door self-latch keeps the door in the open position and keeps the employee safe when scooping ice.

**Ergonomic Door design** Door is angled 53 degrees to allow for easier access to the ice in the bin especially when scooping from the bottom.

**Duratech Metal Finish** Manitowoc exterior material has better corrosion resistance than stainless steel, is smudge resistant and easy to keep clean.

**New Bin liner** Polyurethane Artic Blue bin liner accentuates the crisp clear ice from a Manitowoc Ice Machine.

## Warranty

Bin & Accessories: 3 Year Parts & Labor.

D Bin Model	D-Bin Capacities						D-Bin Dimensions					
	*Application Capacity		**2017 AHRI Capacity		**2018 AHRI Capacity		Height		Width		Depth	
	lbs.	kgs.	lbs.	kgs.	Cu. ft	Cu. M	in.	cm	in.	cm	in.	cm
D320	264	119.90	210	95.25	8.9	0.25	38	96.5	22	55.9	34	86.4
D420	383	173.79	310	140.61	12.9	0.37	50	127	22	55.9	34	86.4
D400	365	165.70	290	131.54	12.3	0.35	38	96.5	30	76.2	34	86.4
D570	532	241.14	430	195.05	17.9	0.51	50	127	30	76.2	34	86.4
D970	882	400.11	710	322.05	29.7	0.84	50	127	48	121.9	34	86.4

\*Application Capacity is based on 90% of the volume x 33 lbs/ft<sup>3</sup> average density of ice. Ice must be managed  
 \*\*2017 Approved AHRI capacity is based on 80% of the total volume x 30 lbs/ft<sup>3</sup> average density of ice  
 \*\*\*2018 AHRI certified measurement for bin capacity

Above bin heights include leg height of 6" / 15.24 cm  
 All bins include sanitary plastic ice scoop and one set of adjustable (6 in to 7.75 in / 15.24 to 20.32 cm) chrome legs  
 External Scoop holder order separately Kit # 000461



Welbilt reserves the right to make changes to the design or specifications without prior notice.



## D Bins

Indigo Ice Machines Series												
Machine			iT420	iT620	i300	iT450	iT500	iF600, iF600C	iF900, iF900C	iT1200, iT1200C	iF1400C iF1800C iF2100C	iT1500, iT1900
Machine Capacity @90/70 F			375	465	240	378	440	555, 530	710, 714	950, 1000	1200 1470 1600	1360, 1455
Bins	Bin Cap	Width	22"	22"	30"	30"	30"	30"	30"	30"	30"	48"
D320	264	22"	*	*								
D420	383	22"	*	*								
D400	365	30"	K00472	K00472	*	*	*	*	NR	NR	NR	
D570	532	30"	K00472	K00472	*	*	*	*	*	*	NR	
D970	882	48"	NR	NR	NR	K00470	K00470	K00470	K00470	K00470	K00471 + K00470	*

Manitowoc Flaker and Nugget Machines											
Machine			RNS0308 & RNF320	RF50300 &RFF320	RNF620	RFF0620	RNF1020	RFF1220	RNF1100	RFF1300	RFF2200C
Machine cap			251	286	451	540	825	958	825	874	1702
Bins	Bin cap	Width	22"	22"	22"	22"	22"	22"	30"	30"	36.7"
D320	264	22"	*	*	NR	NR	NR	NR			
D420	383	22"	*	*	*	*	NR	NR			
D400	365	30"	K00472	K00472	K00472	K00472	NR	NR	NR	NR	
D570	532	30"	NR	K00472	K00472	K00472	NR	NR	*	*	
D970	882	48"	NR	NR	K00473	K00473	K00473 if 2 used.	K00473 if 2 used.	K00470	K00470	K00470

An optional adapter is required when putting a narrower ice machine on a wider bin.

\* No adapter is needed

NR= Not Recommend. Bin too small or too large for application.

Putting a wider machine on narrower bin is not an option.

Machines side by side must be water cooled or remote.

Application Bin Capacity shown in lbs using the AHRI rating based on 90% of total volume x 33 lbs/ft<sup>3</sup> average density of ice.

Machine capacity shown in lbs/24hrs using the AHRI rating base at 90F ambient, 70F water temperature

## Ice Storage Bins

### Available Accessories See price book for replacement: scoops, legs, specialty legs and casters

#### K00146 Convenient Ice Bagger

Includes bagger, D-bin adapter, and 250 bags and ties (Not for D320 or D400) Order K00068 replacement bags



#### K00461 External Scoop Holder

NSF approved. Can be mounted on the left or right side of bins, horizontally or vertically or on a wall.



#### K00463 Metal Scoop

Indestructible NFS approved aluminum alloy with sanitary knuckle and thumb guard. Works with K00461 external scoop holder or hangs inside the D-Bin series. Limited life time guarantee. (Available October 2018)



#### K00462 Secure Fastening Kit

Securely fast the Indigo<sup>®</sup> ice machine head to the pre-drilled inserts on the back of the D-bin series. Stainless steel flanged feet attach to bin and can be screwed to the floor



Welbilt reserves the right to make changes to the design or specifications without prior notice.