

FH1-2-AAC-(HD)

SAFETEMP® REACH-IN FREEZERS

SAFETEMP® Self-Contained Reach-In Freezers

Item # _____

Project: _____

Qty: _____

*AutoCad available on KCL

FH1-2-AAC-(HD)

8/06

Item # 13140

FH1-AAC-(HD) DIMENSIONS

W x D x H

27.5 x 33.6 x 82.5*

*with 4" casters

FH2-AAC-(HD) DIMENSIONS

W x D x H

55 x 33.6 x 82.5*

*with 4" casters

Cabinet Construction

- Stainless steel doors, front panel and interior floor, along with Anodized aluminum sides and interior for long life, durability and easy maintenance
- (3) heavy duty epoxy shelves per unit are standard; Mounted on stainless steel pilasters shelves are adjustable in 1" increments
- Cabinet door perimeter heater provides condensation control in high humidity environments and is equipped with a back-up heater should the primary heater fail; Manual power switch allows for energy savings in low humidity conditions
- Cabinet and doors are 2 3/8" thick, insulated with R-134A, CFC free foamed in place polyurethane
- Interior light automatically activated when doors are opened
- 4" heavy duty casters

Door Construction

- Doors are constructed of high grade 300 Series stainless steel inside and out (HD: Two half doors per section)
- Flush mount door handles maximize aisle space by eliminating protruding parts
- Door hinges are all metal with tension spring closure and will not wear out like traditional cam-lift hinges; Doors stay open at 105° and are self-closing at 75°; Door hinge spring tension is adjustable
- Step door design protects door gasket when product is removed from the box; Snap-in magnetic door gaskets are durable and easily removed
- Door hinging is field reversible

Refrigeration System

- High efficiency refrigeration system is designed with a large capacity condenser and evaporator resulting in lower overall power consumption
- Refrigeration system is mounted on a fully insulated rotocast platform and is easily removable from the main unit
- Evaporator coil is coated for extended life
- Refrigeration system equipped with solid state digital controls
- Controls can be set to initiate heated defrost cycles every 3, 4, 8, 12 or 24 hours as required
- Removable, cleanable air filter protects condenser and reduces cleaning requirements
- Hot gas condensate evaporator is standard with a condensate overflow tube to direct excess water away from top of cabinet under extreme conditions
- Electric condensate evaporator is standard
- Refrigerant: R-404A with expansion valve control

* The FH1-AAC, FH2-AAC and the FH2-AAC-HD freezers are ENERGY STAR certified.

**FH1-AAC-(HD)****FH2-AAC-(HD)****Warranty**

Valid in United States, Canada, Puerto Rico, & U.S. Territories. Contact factory for warranty in other countries.

Two Year - Parts & Labor on entire machine.**Five Year** - Parts on: Compressor.

© HOSHIZAKI AMERICA, INC.

618 Hwy. 74 S., Peachtree City, GA 30269

TEL 1-800-438-6087

FAX 1-800-345-1325

www.hoshizaki.com



Hoshizaki

FH1-2-AAC-(HD) SAFETEMP® FREEZERS

DIMENSIONS

W x D x H

FH1-AAC-(HD)
27.5" x 33.6" x 82.5"
* with 4" casters

FH2-AAC-(HD)
55" x 33.6" x 82.5"
* with 4" casters

- 1 section freezer
- 2 section freezer

DIMENSIONS/CAPACITY

Model #	One Section FH1-AAC-(HD)	Two Section FH2-AAC-(HD)
Interior Storage Capacity (CF)	22.3 ft ³	48.3 ft ³
Overall Width	27.5"	55"
Overall Depth	33.6"	33.6"
Height (including 4" casters)	82.5"	82.5"
Depth with Door open at 90°	58.5"	58.5"
Door Opening Width	21.75" ea.	21.75" ea.
Door Opening Height (Full Door)	59.25"	59.25"
Door Opening Height (Half Door)	26.75"	26.75"
Adjustable Shelves/Center Shelves	3 / NA	6 / 3
Shelf Dimensions (W x D)	21.25" x 26"	21.25" x 26"
Crated Shipping Weight	400 lb	575 lb
Crated Height	85"	85"
Crated Width	32"	59"
Crated Depth	38"	38"

ELECTRICAL & REFRIGERATION DATA

Model #	One Section FH1-AAC-(HD)	Two Section FH2-AAC-(HD)
Voltage	115/60/1	115/60/1
Amperage	11.0	15.5
HACR Breaker	15.0	20.0
Electrical Connection(NEMA)	5 - 15P	5 - 15P
*Energy Consumption(kwh/day)	15.0	23.6
* Heat Rejection(BTU/Hr.)	2158	3355
Approximate Nominal Compressor BTU/Hr.(HP)	2450 (2/3 hp)	3690 (1 hp)
Voltage Range	104 - 126	104 - 126
Ambient Temp. Range	45° - 100°F	45° - 100°F
Control Setpoint Range	-10° - +28°F	-10° - +28°F
*Refrigerant	R-404A	R-404A

* Based on 100°F ambient cycling at setpoint

OPTIONS

- 6" Die-cast legs w/stainless steel feet
- Additional epoxy (center) shelves
- Patented foot pedal door opener
- Door reversal kit
- Stainless steel shelves
- Universal combination tray/pan slides



© HOSHIZAKI AMERICA, INC.

618 Hwy. 74 S., Peachtree City, GA 30269

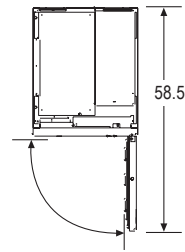

DOOR SWING (ALL UNITS)

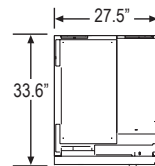

PLAN VIEW

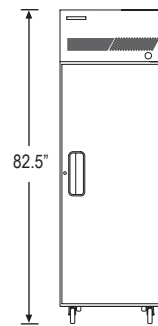

FH1-AAC

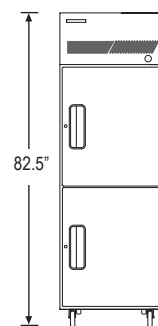

FH1-AAC-HD

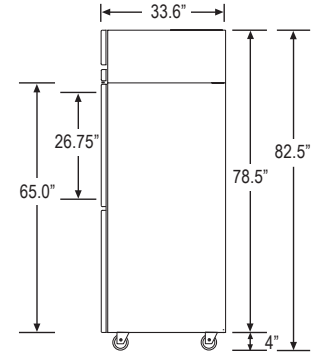

SIDE VIEW (ALL UNITS)

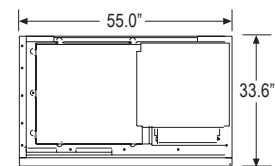

PLAN VIEW

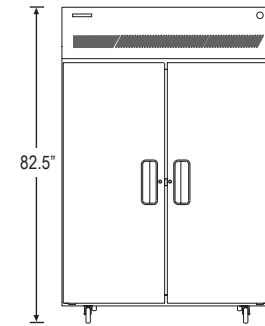

FH2-AAC

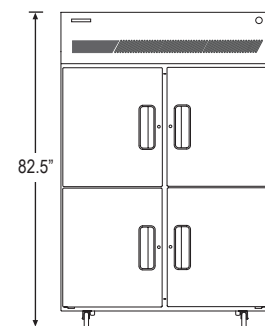

FH2-AAC-HD

