

KM-901M_H-P

MODULAR CRESCENT CUBER

TAMPER PROOF MODEL

Item # _____

Project: _____

Qty: _____

*AutoCad available on KCL

KM-901M_H-P

5/14

Item #13319

CUBER DIMENSIONS

W x D x H

KM-901M_H-P
30 x 27^{3/8} x 37^{1/16}



Exterior Fasteners are Tamper Proof Torx Pin Screws



Shown on standard bin for placement only.



KM-901MAH-P
Air-Cooled

KM-901MWH-P
Water-Cooled

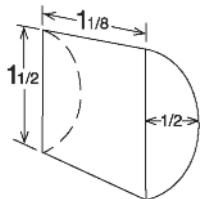
KM CUBE DIMENSIONS



**approximate size in inches, image not to scale

- Up to 928 lbs. of ice production per 24 hours
- Durable stainless steel exterior
- Individual crescent cube
- Protected by H-GUARD Plus Antimicrobial Agent 
- CycleSaver® Design 
- EverCheck® alert system 
- Stainless steel evaporator
- Removable air filters located under front panel (Air-cooled model only)
- R-404A Refrigerant



Warranty

Valid in United States, Canada, Puerto Rico, & U.S. Territories. Contact factory for warranty in other countries.

Three Year - Parts & Labor on entire machine.

Five Year - Parts & Labor on: Evaporator.

Five Year - Parts on: Compressor, air-cooled condenser coil.



Hoshizaki

KM-90IM_H-P MODULAR CRESCENT CUBER

DIMENSIONS
W x D x H
KM-90IM_H-P
30 x 27^{3/8} x 37^{7/16}

- Air-cooled
- Water-cooled

AIR-COOLED

Water Temp ° F.	50°	70°	90°
Air Temp ° F.	70°	889	841
	80°	896	797
	90°	889	813

WATER-COOLED

Water Temp ° F.	50°	70°	90°
Air Temp ° F.	70°	928	857
	80°	914	817
	90°	909	864

UTILITY CONSUMPTION

Model Number	Ice Production Per Cycle		KWH per 100 LBS.	Potable Water Gal. per 100 lbs.	Condenser Water Gal. per 100 lbs.
	Lbs.	Cubes			
KM-901MAH-P	14.2	720	5.1	16.0	N/A
KM-901MWH-P	13.7	720	4.5	20.8	128

SPECIFICATIONS

Model Number	Condenser	Amperage	Min. Circuit Ampacity	Shipping Weight
KM-901MAH-P	Air-Cooled	11.4	20	256 lbs.
KM-901MWH-P	Water-Cooled	8.7	15	249 lbs.

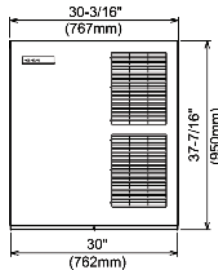

FRONT VIEW

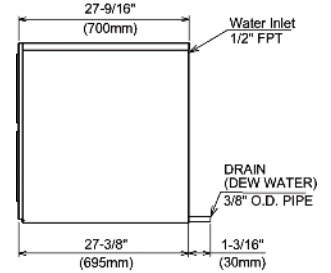

SIDE VIEW

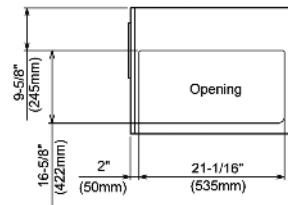

ICE DROP ZONE

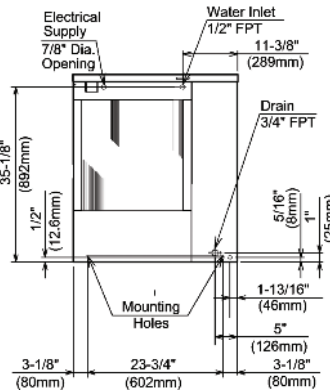

AIR-COOLED UNIT

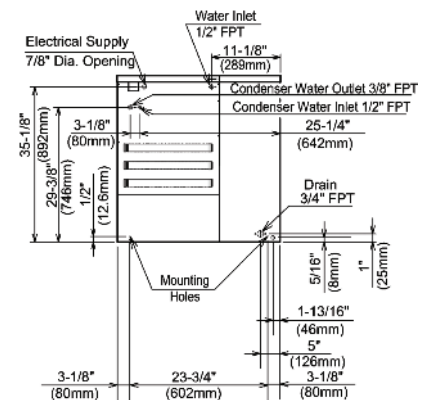

WATER-COOLED UNIT

ELECTRICAL & PLUMBING/KM-90IM_H-P

- 208-230V/60/1
- 20 amp Max Fuse/HACR Breaker Size - Air-cooled units
- 15 amp Max Fuse/HACR Breaker Size - Water-cooled unit
- 1/2" OD copper or equivalent independent potable water supply with 3/8" nominal ID minimum
- 3/4" FPT independent drain connection



BSL09001-15C14901

© HOSHIZAKI AMERICA, INC.

618 Hwy. 74 S., Peachtree City, GA 30269

OPERATING LIMITS

- Ambient Temp Range 45 - 100°F
- Water Temp Range 45 - 90°F
- Water Pressure 10 - 113psig
- Voltage Range 187 - 253V

SERVICE

- Panels easily removed and all components accessible for service.
- Removable/cleanable air filters under front panel (Air-cooled model only)
- Exterior fasteners are tamper proof torx pin screws.

TEL 1-800-438-6087

FAX 1-800-345-1325

www.hoshizaki.com

Printed in U.S.A.

