



PROJECT NAME		LOCATION		AIA #
ITEM #	QTY	MODEL #		SIS #

SPEC SERIES®

ROLL-THRU SOLID SWING DOOR REFRIGERATOR

models	STR1RRT89-1S-1S	STA1RRT89-1S-1S	STG1RRT89-1S-1S
--------	-----------------	-----------------	-----------------



STR1RRT89-1S-1S	
Exterior	Stainless steel door, front & sides.
Interior	Stainless steel side walls, back, floor, door liner, & ceiling.

STA1RRT89-1S-1S	
Exterior	Stainless steel door, front & sides.
Interior	Aluminum side walls & back. Stainless steel floor & ceiling.

STG1RRT89-1S-1S	
Exterior	Stainless steel door, with matching aluminum sides.
Interior	Aluminum side walls & back. Stainless steel floor & ceiling.

plan view

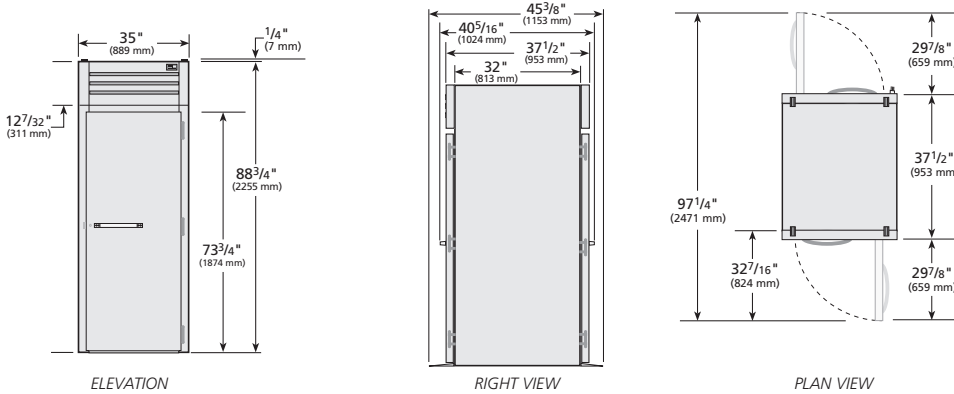

SPECIFICATIONS		
Dimensions	in.	mm.
Width	35	889
Depth	37 1/2	953
Height	88 3/4	2255
Electrical	U.S.	International
Horsepower	1/3	N/A
Amps	8.9	N/A
Voltage	115/60/1	
NEMA	5-15P	
Cord Length	9 ft.	2.74 M.
115/60/1 NEMA-5-15R * Depth does not include 4 1/4" (108 mm) each side for ramps. * Height does not include 1" (26 mm) for system mechanical components.		

Specifications subject to change without notice.
 Chart dimensions are rounded up to the nearest 1/8" (millimeters rounded up to the next whole number).

	APPROVALS	AVAILABLE AT
3/17	Printed in U.S.A.	



PROJECT NAME	LOCATION	AIA #
ITEM #	QTY	MODEL #
		SIS #

SPEC SERIES®

ROLL-THRU SOLID SWING DOOR REFRIGERATOR

models	STR1RRT89-1S-1S	STA1RRT89-1S-1S	STG1RRT89-1S-1S
--------	-----------------	-----------------	-----------------



standard features

REFRIGERATION SYSTEM

- Factory engineered, self-contained, capillary tube system using environmentally friendly (CFC free) 134A refrigerant.
- Extra large evaporator coil balanced with higher horsepower compressor and large condenser maintains cabinet temperatures of 33°F to 38°F (.5°C to 3.3°C) for the best in food preservation.
- Sealed, cast iron, self-lubricating evaporator fan motor(s) and larger fan blades give True roll-in's a more efficient low velocity, high volume airflow design. This unique design ensures faster temperature recovery and shorter run times in the busiest of foodservice environments.
- Top mounted refrigeration system with evaporator positioned out of food zone to maximize capacity.

CABINET CONSTRUCTION

- Insulation - entire cabinet structure and solid door are foamed-in-place using a high density, polyurethane insulation that has zero ozone depletion potential (ODP) and zero global warming potential (GWP).
- Two (2) heavy gauge stainless steel ramps (one per door).
- Designed to accept roll-in racks (inboard castors) with maximum dimensions of 27"L x 29"D x 72"H (686 mm x 737 mm x 1829 mm)(supplied by others).

DOORS

- Lifetime guaranteed bolt style door lock standard.
- Lifetime guaranteed heavy duty all metal working door handle.
- Positive seal self-closing door with 120° stay open feature. Lifetime guaranteed external cam lift door hinges, Three (3) per door section.
- Magnetic door gasket of one piece construction, removable without tools for ease of cleaning.

LIGHTING

- Incandescent interior lighting, safety shielded.

MODEL FEATURES

- Exterior digital temperature display, available with either °F or °C .
- Evaporator epoxy coated to eliminate the potential of corrosion
- Interior bumpers protect cabinet walls from abuse caused by roll-in carts.
- NSF/ANSI Standard 7 compliant for open food product.

ELECTRICAL

- Unit completely pre-wired at factory and ready for final connection to a 115/60/1 phase, 15 amp dedicated outlet. Cord and plug set included.

OPTIONAL FEATURES/ ACCESSORIES

- (upcharge & lead times may apply)*
- Field reversible hinge.

WARRANTY*

Three year warranty on all parts and labor and an additional 2 year warranty on compressor. (U.S.A. only)

METRIC DIMENSIONS ROUNDED UP TO THE NEAREST WHOLE MILLIMETER

SPECIFICATIONS SUBJECT TO CHANGE WITHOUT NOTICE

*RESIDENTIAL APPLICATIONS: TRUE assumes no liability for parts or labor coverage for component failure, factory defect or any other damages for units installed in non-commercial foodservice or residential applications.



Model	Elevation	Right	Plan	3D	Back
ST()1RRT89-1S-1S					