

- KDT-0420A
- KYT-0420A
- KDT-0420W
- KYT-0420W



# KT-0420 Ice Kube Machine



- Easy access to food zone with removal of two screws and lift-off door
- High-tech exterior with smudge and fingerprint resistant stainless-like finish
- White plastics in the food zone help identify areas needing cleaning
- Water shield, distribution tube, pump, floats, and trough removable by hand
- Available CleanAir™ pack controls the growth of bacteria and fungi that form slime and cause odors in the food zone

**WARRANTY:**

Ice Maker: 3 year Parts & Labor  
 Evaporator: 5 year Parts & Labor  
 Compressor: 5 year Parts & 3 year Labor



**HALF KUBE**

$\frac{3}{8}'' \times 1\frac{1}{8}'' \times \frac{7}{8}''$   
 (.95 x 2.86 x 2.22 cm)

= 100%



**KUBE**

$\frac{7}{8}'' \times \frac{7}{8}'' \times \frac{7}{8}''$   
 (2.22 x 2.22 x 2.22 cm)

= 100%



**KT-0420**  
 ICE KUBE MACHINE

*Koolaire KT-0420 Ice Kube Machine on a K420 bin.*











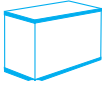







By MANITOWOC









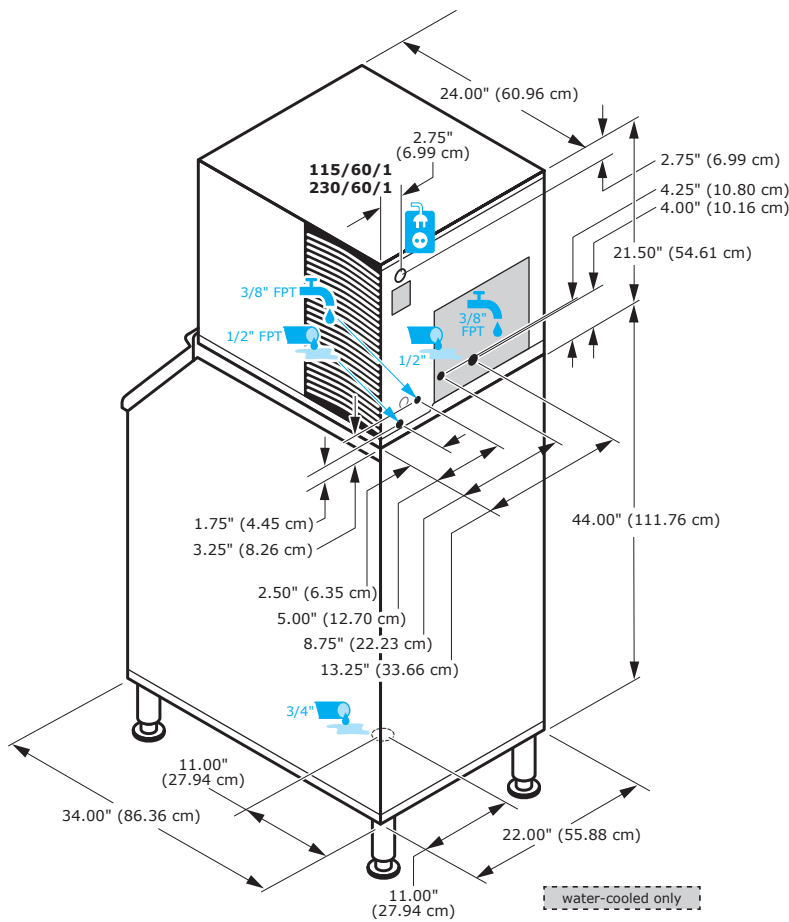





2110 SOUTH 26TH ST | MANITOWOC, WI 54220 USA | 1-920-682-0161 [ [www.kool-aire.com](http://www.kool-aire.com) ]



# KT-0420 ICE KUBE MACHINE

				 				
				70°/50°F 21°/10°C	90°/70°F 32°/21°C	[kWh/ 100 lbs ice]	[gal/100 lbs ice]	
KDT-0420A			440 lbs	350 lbs	5.8	19	•	
			199 kg	159 kg				
KYT-0420A			450 lbs	360 lbs	5.5	19	•	
			204 kg	163 kg				
KDT-0420W			457 lbs	375 lbs	4.6	19		
			207 kg	170 kg				
KYT-0420W			435 lbs	390 lbs	4.6	19		
			197 kg	177 kg				



		
Minimum		Maximum
40°F 4.4°C		110°F 43.3°C
40°F 4.4°C		90°F 32.2°C
20psi 138 kPa		80psi 551 kPa
 10.3		
 9.6		
		15 Amps
 136 lbs 62 kg		
 132 lbs 60 kg		

Water cooled condenser water usage /100lbs. or 45.4kg. of ice: 160 gals. / 606L.

Popular Accessories			
Artic Pure Water Filters	Dispenser Bin Thermostat Kit	Top Air Discharge Kit	Clean Air Pack
AR-Pre & AR 10000	K-00457	K-00438	K-00206

## KOOLAIRE

By  MANITOWOC

2110 SOUTH 26TH ST | MANITOWOC, WI 54220 USA | 1-920-682-0161 [ [www.kool-aire.com](http://www.kool-aire.com) ]